

JFET Chopper Transistor

N-Channel — Depletion

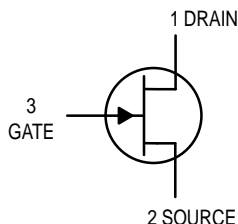

J112

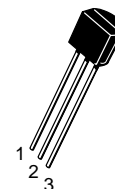

CASE 29-04, STYLE 5
TO-92 (TO-226AA)

MAXIMUM RATINGS

Rating	Symbol	Value	Unit
Drain–Gate Voltage	V_{DG}	–35	Vdc
Gate–Source Voltage	V_{GS}	–35	Vdc
Gate Current	I_G	50	mAdc
Total Device Dissipation @ $T_A = 25^\circ\text{C}$ Derate above 25°C	P_D	350 2.8	mW mW/ $^\circ\text{C}$
Lead Temperature	T_L	300	$^\circ\text{C}$
Operating and Storage Junction Temperature Range	T_J, T_{stg}	–65 to +150	$^\circ\text{C}$

ELECTRICAL CHARACTERISTICS ($T_A = 25^\circ\text{C}$ unless otherwise noted)

Characteristic	Symbol	Min	Max	Unit
----------------	--------	-----	-----	------

OFF CHARACTERISTICS

Gate–Source Breakdown Voltage ($I_G = -1.0 \mu\text{Adc}$)	$V_{(BR)GSS}$	35	—	Vdc
Gate Reverse Current ($V_{GS} = -15 \text{Vdc}$)	I_{GSS}	—	–1.0	nAdc
Gate Source Cutoff Voltage ($V_{DS} = 5.0 \text{Vdc}, I_D = 1.0 \mu\text{Adc}$)	$V_{GS(off)}$	–1.0	–5.0	Vdc
Drain–Cutoff Current ($V_{DS} = 5.0 \text{Vdc}, V_{GS} = -10 \text{Vdc}$)	$I_{D(off)}$	—	1.0	nAdc

ON CHARACTERISTICS

Zero–Gate–Voltage Drain Current ⁽¹⁾ ($V_{DS} = 15 \text{Vdc}$)	I_{DSS}	5.0	—	mAdc
Static Drain–Source On Resistance ($V_{DS} = 0.1 \text{Vdc}$)	$r_{DS(on)}$	—	50	Ω
Drain Gate and Source Gate On–Capacitance ($V_{DS} = V_{GS} = 0, f = 1.0 \text{MHz}$)	$C_{dg(on)}$ + $C_{sg(on)}$	—	28	pF
Drain Gate Off–Capacitance ($V_{GS} = -10 \text{Vdc}, f = 1.0 \text{MHz}$)	$C_{dg(off)}$	—	5.0	pF
Source Gate Off–Capacitance ($V_{GS} = -10 \text{Vdc}, f = 1.0 \text{MHz}$)	$C_{sg(off)}$	—	5.0	pF

1. Pulse Width = 300 μs , Duty Cycle = 3.0%.

(Replaces J111/D)

TYPICAL SWITCHING CHARACTERISTICS

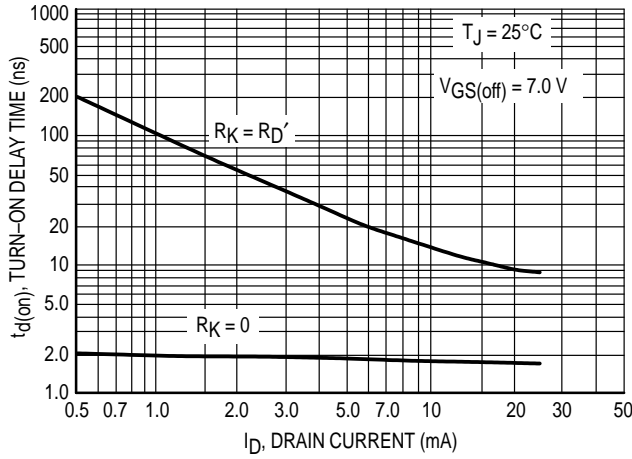

Figure 1. Turn-On Delay Time

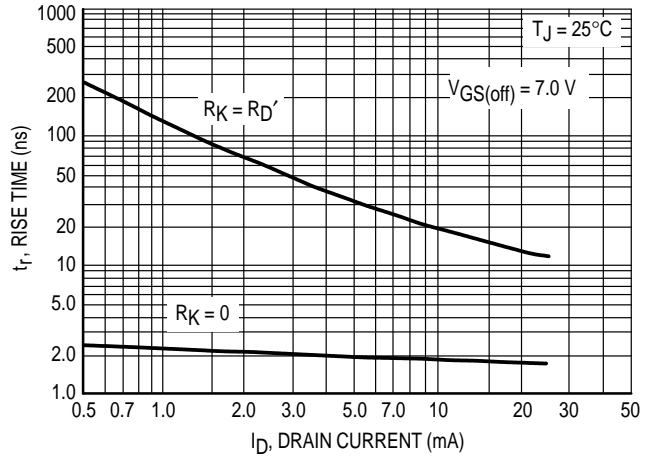

Figure 2. Rise Time

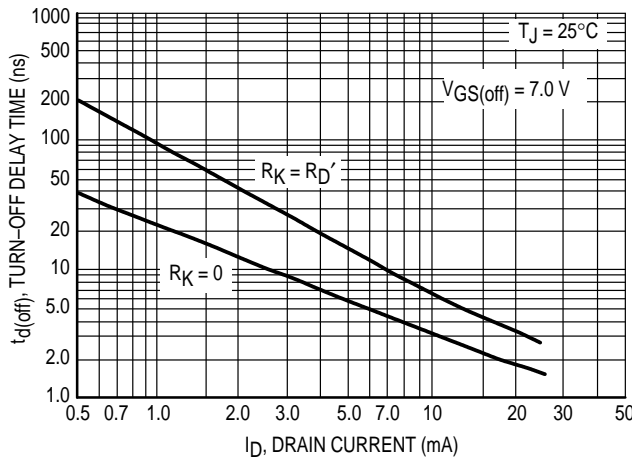

Figure 3. Turn-Off Delay Time

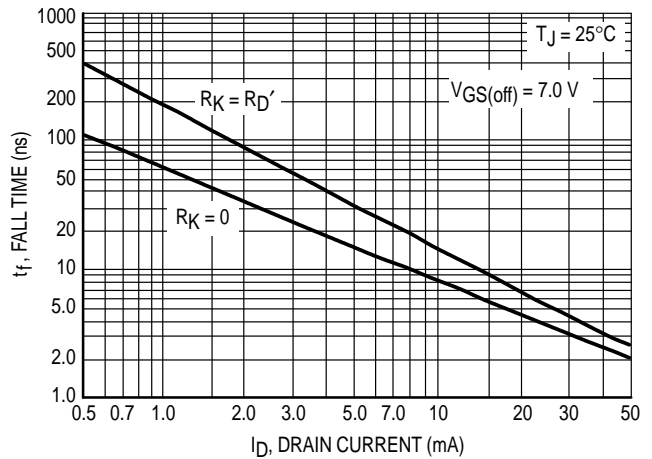

Figure 4. Fall Time

NOTE 1

The switching characteristics shown above were measured using a test circuit similar to Figure 5. At the beginning of the switching interval, the gate voltage is at Gate Supply Voltage ($-V_{GG}$). The Drain-Source Voltage (V_{DS}) is slightly lower than Drain Supply Voltage (V_{DD}) due to the voltage divider. Thus Reverse Transfer Capacitance (C_{RSS}) or Gate-Drain Capacitance (C_{gd}) is charged to $V_{GG} + V_{DS}$.

During the turn-on interval, Gate-Source Capacitance (C_{GS}) discharges through the series combination of R_{GEN} and R_K . C_{gd} must discharge to $V_{DS(on)}$ through R_G and R_K in series with the parallel combination of effective load impedance (R'_D) and Drain-Source Resistance (r_{DS}). During the turn-off, this charge flow is reversed.

Predicting turn-on time is somewhat difficult as the channel resistance r_{DS} is a function of the gate-source voltage. While C_{GS} discharges, V_{GS} approaches zero and r_{DS} decreases. Since C_{gd} discharges through r_{DS} , turn-on time is non-linear. During turn-off, the situation is reversed with r_{DS} increasing as C_{gd} charges.

The above switching curves show two impedance conditions; 1) R_K is equal to R_D , which simulates the switching behavior of cascaded stages where the driving source impedance is normally the load impedance of the previous stage, and 2) $R_K = 0$ (low impedance) the driving source impedance is that of the generator.

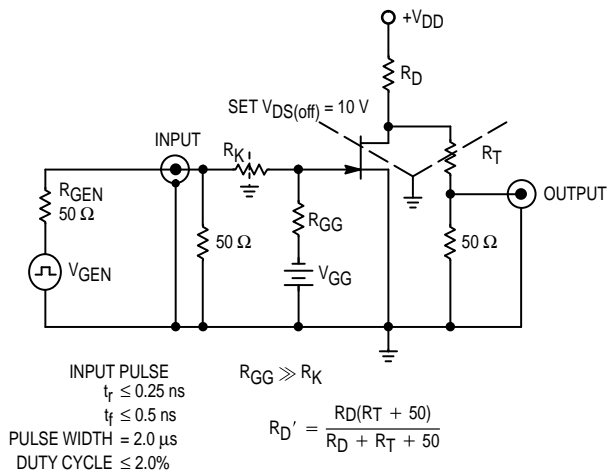

Figure 5. Switching Time Test Circuit

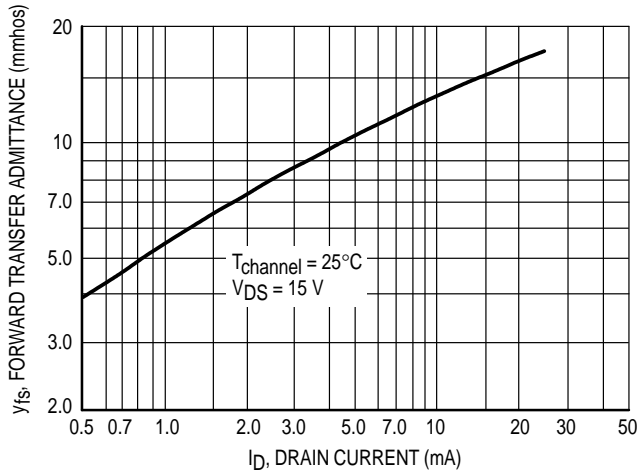

Figure 6. Typical Forward Transfer Admittance

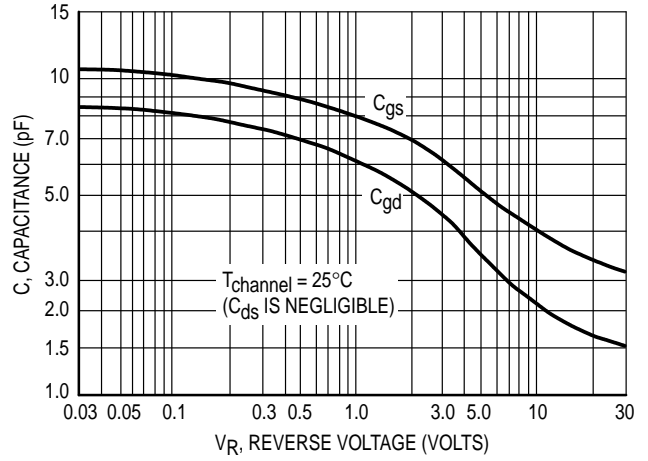

Figure 7. Typical Capacitance

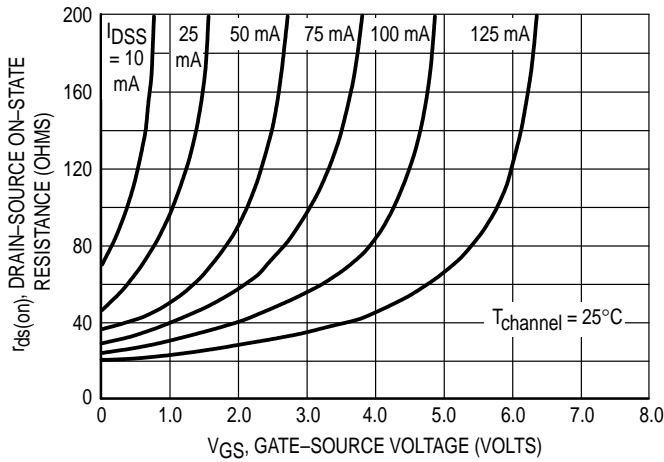

Figure 8. Effect of Gate-Source Voltage On Drain-Source Resistance

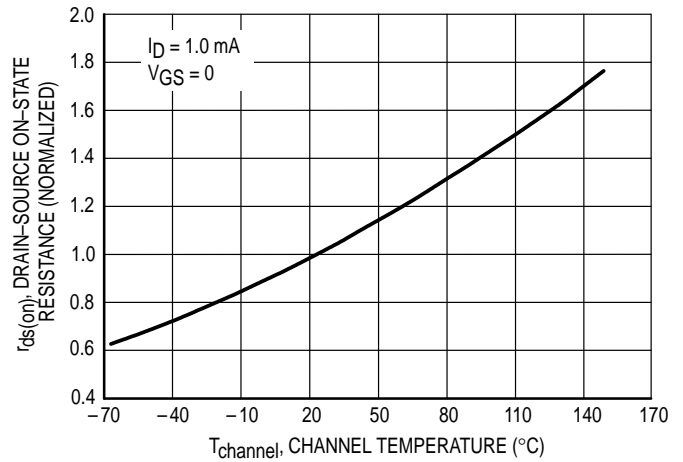

Figure 9. Effect of Temperature On Drain-Source On-State Resistance

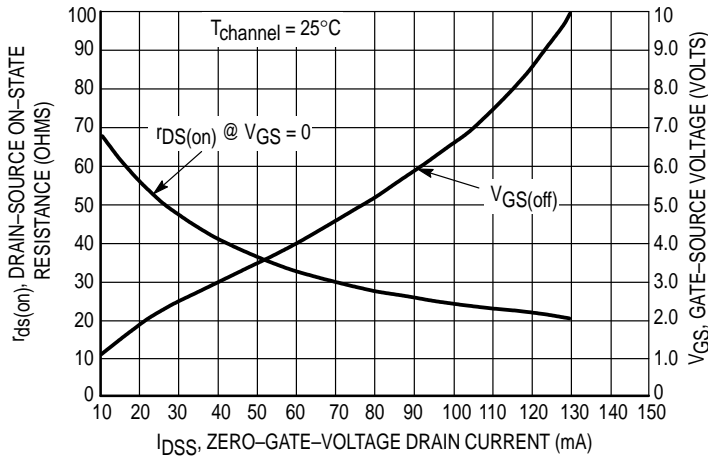

Figure 10. Effect of IDSS On Drain-Source Resistance and Gate-Source Voltage

NOTE 2

The Zero-Gate-Voltage Drain Current (I_{DSS}), is the principle determinant of other J-FET characteristics. Figure 10 shows the relationship of Gate-Source Off Voltage ($V_{GS(off)}$) and Drain-Source On Resistance ($r_{ds(on)}$) to I_{DSS} . Most of the devices will be within $\pm 10\%$ of the values shown in Figure 10. This data will be useful in predicting the characteristic variations for a given part number.

For example:

Unknown

$r_{ds(on)}$ and V_{GS} range for an J112

The electrical characteristics table indicates that an J112 has an I_{DSS} range of 25 to 75 mA. Figure 10, shows $r_{ds(on)} = 52$ Ohms for $I_{DSS} = 25$ mA and 30 Ohms for $I_{DSS} = 75$ mA. The corresponding V_{GS} values are 2.2 volts and 4.8 volts.

PACKAGE DIMENSIONS

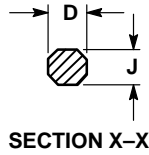
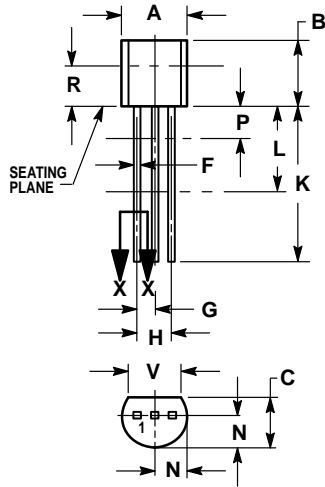

NOTES:

1. DIMENSIONING AND TOLERANCING PER ANSI Y14.5M, 1982.
2. CONTROLLING DIMENSION: INCH.
3. CONTOUR OF PACKAGE BEYOND DIMENSION R IS UNCONTROLLED.
4. DIMENSION F APPLIES BETWEEN P AND L. DIMENSION D AND J APPLY BETWEEN L AND K. MINIMUM LEAD DIMENSION IS UNCONTROLLED IN P AND BEYOND DIMENSION K MINIMUM.

DIM	INCHES		MILLIMETERS	
	MIN	MAX	MIN	MAX
A	0.175	0.205	4.45	5.20
B	0.170	0.210	4.32	5.33
C	0.125	0.165	3.18	4.19
D	0.016	0.022	0.41	0.55
F	0.016	0.019	0.41	0.48
G	0.045	0.055	1.15	1.39
H	0.095	0.105	2.42	2.66
J	0.015	0.020	0.39	0.50
K	0.500	—	12.70	—
L	0.250	—	6.35	—
N	0.080	0.105	2.04	2.66
P	—	0.100	—	2.54
R	0.115	—	2.93	—
V	0.135	—	3.43	—

**CASE 029-04
(TO-226AA)
ISSUE AD**

STYLE 5:
PIN 1. DRAIN
2. SOURCE
3. GATE

Motorola reserves the right to make changes without further notice to any products herein. Motorola makes no warranty, representation or guarantee regarding the suitability of its products for any particular purpose, nor does Motorola assume any liability arising out of the application or use of any product or circuit, and specifically disclaims any and all liability, including without limitation consequential or incidental damages. "Typical" parameters which may be provided in Motorola data sheets and/or specifications can and do vary in different applications and actual performance may vary over time. All operating parameters, including "Typicals" must be validated for each customer application by customer's technical experts. Motorola does not convey any license under its patent rights nor the rights of others. Motorola products are not designed, intended, or authorized for use as components in systems intended for surgical implant into the body, or other applications intended to support or sustain life, or for any other application in which the failure of the Motorola product could create a situation where personal injury or death may occur. Should Buyer purchase or use Motorola products for any such unintended or unauthorized application, Buyer shall indemnify and hold Motorola and its officers, employees, subsidiaries, affiliates, and distributors harmless against all claims, costs, damages, and expenses, and reasonable attorney fees arising out of, directly or indirectly, any claim of personal injury or death associated with such unintended or unauthorized use, even if such claim alleges that Motorola was negligent regarding the design or manufacture of the part. Motorola and are registered trademarks of Motorola, Inc. Motorola, Inc. is an Equal Opportunity/Affirmative Action Employer.

Mfax is a trademark of Motorola, Inc.

How to reach us:

USA/EUROPE/Locations Not Listed: Motorola Literature Distribution;
P.O. Box 5405, Denver, Colorado 80217. 303-675-2140 or 1-800-441-2447

JAPAN: Nippon Motorola Ltd.: SPD, Strategic Planning Office, 4-32-1,
Nishi-Gotanda, Shinagawa-ku, Tokyo 141, Japan. 81-3-5487-8488

Mfax™: RMFAX0@email.sps.mot.com – TOUCHTONE 602-244-6609
– US & Canada ONLY 1-800-774-1848

ASIA/PACIFIC: Motorola Semiconductors H.K. Ltd.; 8B Tai Ping Industrial Park,
51 Ting Kok Road, Tai Po, N.T., Hong Kong. 852-26629298

INTERNET: <http://motorola.com/sps>

