

Silicon Diffused Power Transistor

BU508DF

GENERAL DESCRIPTION

High voltage, high-speed switching npn transistors in a fully isolated SOT199 envelope with integrated efficiency diode, primarily for use in horizontal deflection circuits of colour television receivers.

QUICK REFERENCE DATA

SYMBOL	PARAMETER	CONDITIONS	TYP.	MAX.	UNIT
V_{CESM}	Collector-emitter voltage peak value	$V_{BE} = 0 \text{ V}$	-	1500	V
V_{CEO}	Collector-emitter voltage (open base)		-	700	V
I_C	Collector current (DC)		-	8	A
I_{CM}	Collector current peak value		-	15	A
P_{tot}	Total power dissipation	$T_{hs} \leq 25 \text{ }^\circ\text{C}$	-	34	W
V_{CESat}	Collector-emitter saturation voltage	$I_C = 4.5 \text{ A}; I_B = 1.6 \text{ A}$	-	1.0	V
I_{Csat}	Collector saturation current	$f = 16\text{kHz}$	4.5	-	A
V_F	Diode forward voltage	$I_F = 4.5 \text{ A}$	1.6	2.0	V
t_f	Fall time	$I_{Csat} = 4.5 \text{ A}; f = 16\text{kHz}$	0.7	-	μs

PINNING - SOT199

PIN	DESCRIPTION
1	base
2	collector
3	emitter
case	isolated

PIN CONFIGURATION

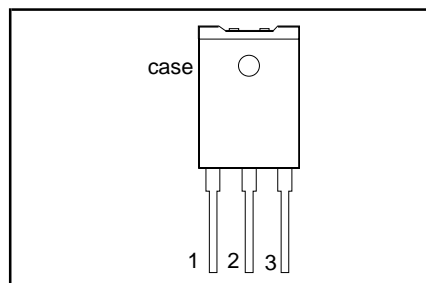

SYMBOL

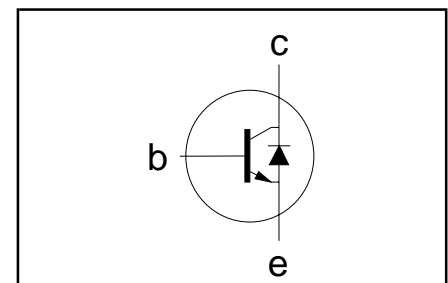

LIMITING VALUES

Limiting values in accordance with the Absolute Maximum Rating System (IEC 134)

SYMBOL	PARAMETER	CONDITIONS	MIN.	MAX.	UNIT
V_{CESM}	Collector-emitter voltage peak value	$V_{BE} = 0 \text{ V}$	-	1500	V
V_{CEO}	Collector-emitter voltage (open base)		-	700	V
I_C	Collector current (DC)		-	8	A
I_{CM}	Collector current peak value		-	15	A
I_B	Base current (DC)		-	4	A
I_{BM}	Base current peak value		-	6	A
P_{tot}	Total power dissipation	$T_{hs} \leq 25 \text{ }^\circ\text{C}$	-	34	W
T_{stg}	Storage temperature		-65	150	$^\circ\text{C}$
T_j	Junction temperature		-	150	$^\circ\text{C}$

THERMAL RESISTANCES

SYMBOL	PARAMETER	CONDITIONS	TYP.	MAX.	UNIT
$R_{th\ j-hs}$	Junction to heatsink	without heatsink compound	-	3.7	K/W
$R_{th\ j-hs}$	Junction to heatsink	with heatsink compound	-	2.8	K/W
$R_{th\ j-a}$	Junction to ambient	in free air	35	-	K/W

Silicon Diffused Power Transistor

BU508DF

ISOLATION LIMITING VALUE & CHARACTERISTIC $T_{hs} = 25\text{ °C}$ unless otherwise specified

SYMBOL	PARAMETER	CONDITIONS	MIN.	TYP.	MAX.	UNIT
V_{isol}	Repetitive peak voltage from all three terminals to external heatsink	R.H. $\leq 65\%$; clean and dustfree	-		2500	V
C_{isol}	Capacitance from T2 to external heatsink	$f = 1\text{ MHz}$	-	22	-	pF

STATIC CHARACTERISTICS $T_{hs} = 25\text{ °C}$ unless otherwise specified

SYMBOL	PARAMETER	CONDITIONS	MIN.	TYP.	MAX.	UNIT
I_{CES}	Collector cut-off current ¹	$V_{BE} = 0\text{ V}; V_{CE} = V_{CESMmax}$	-	-	1.0	mA
I_{CES}		$V_{BE} = 0\text{ V}; V_{CE} = V_{CESMmax}$	-	-	2.0	mA
$V_{CEOsust}$	Collector-emitter sustaining voltage	$T_j = 125\text{ °C}$ $I_B = 0\text{ A}; I_C = 100\text{ mA};$ $L = 25\text{ mH}$	700	-	-	V
V_{CEsat}	Collector-emitter saturation voltages	$I_C = 4.5\text{ A}; I_B = 1.6\text{ A}$	-	-	1.0	V
V_{BEsat}	Base-emitter saturation voltage	$I_C = 4.5\text{ A}; I_B = 2.0\text{ A}$	-	-	1.1	V
h_{FE}	DC current gain	$I_C = 100\text{ mA}; V_{CE} = 5\text{ V}$	6	13	30	
V_F	Diode forward voltage	$I_F = 4.5\text{ A}$	-	1.6	2.0	V

DYNAMIC CHARACTERISTICS $T_{hs} = 25\text{ °C}$ unless otherwise specified

SYMBOL	PARAMETER	CONDITIONS	TYP.	MAX.	UNIT
f_T	Transition frequency at $f = 5\text{ MHz}$	$I_C = 0.1\text{ A}; V_{CE} = 5\text{ V}$	7	-	MHz
C_C	Collector capacitance at $f = 1\text{ MHz}$	$V_{CB} = 10\text{ V}$	125	-	pF
t_s	Switching times (16 kHz line deflection circuit)	$I_{Csat} = 4.5\text{ A}; L_C = 1\text{ mH}; C_{fb} = 4\text{ nF}$ $I_{B(end)} = 1.4\text{ A}; L_B = 6\text{ }\mu\text{H}; -V_{BB} = -4\text{ V};$ $-I_{BM} = 2.25\text{ A}$			
t_s	Turn-off storage time		6.5	-	μs
t_f	Turn-off fall time		0.7	-	μs

¹ Measured with half sine-wave voltage (curve tracer).

Silicon Diffused Power Transistor

BU508DF

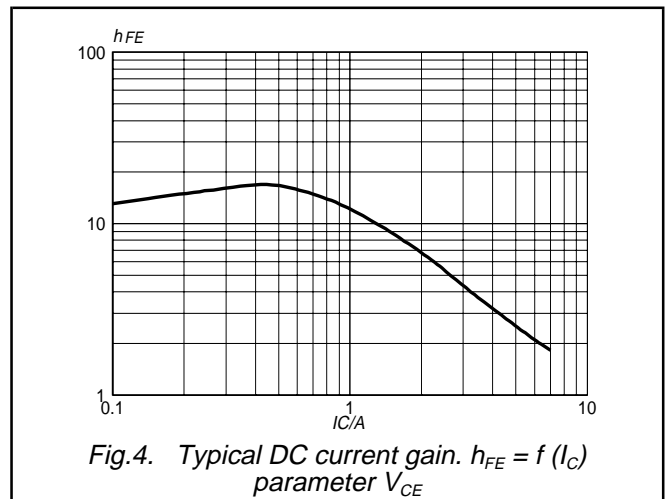
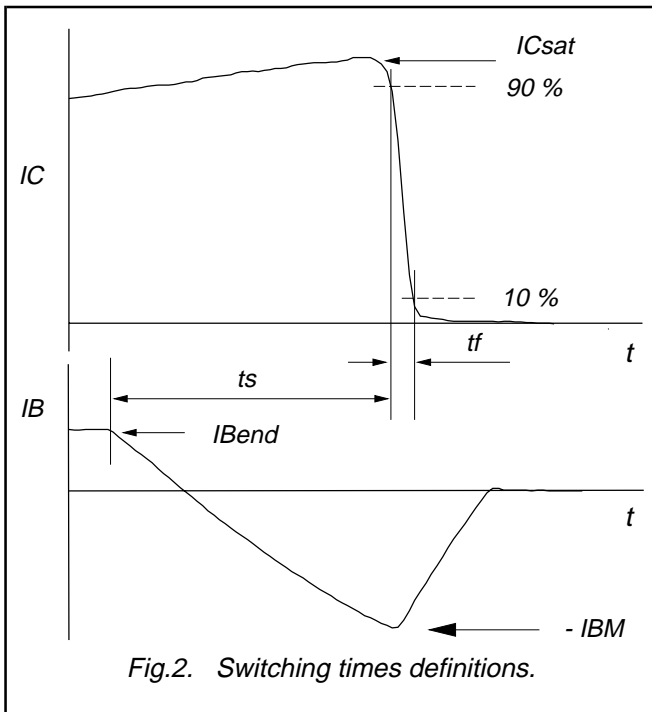
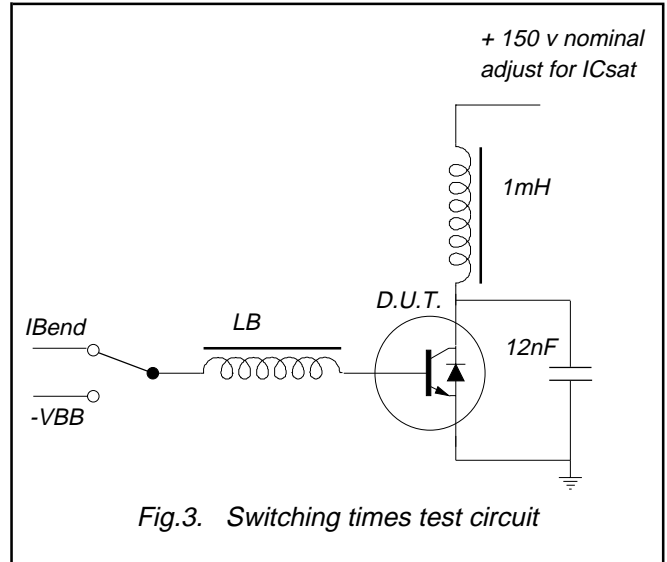
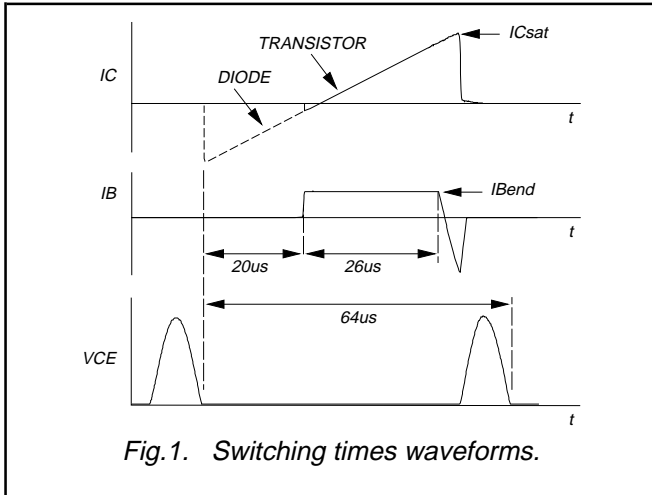

Silicon Diffused Power Transistor

BU508DF

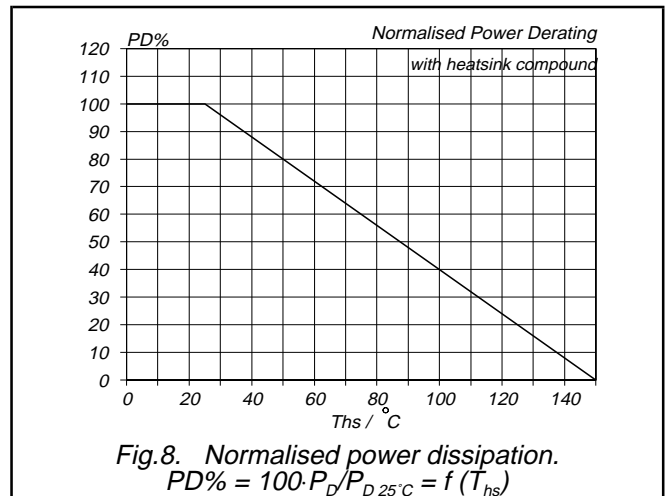
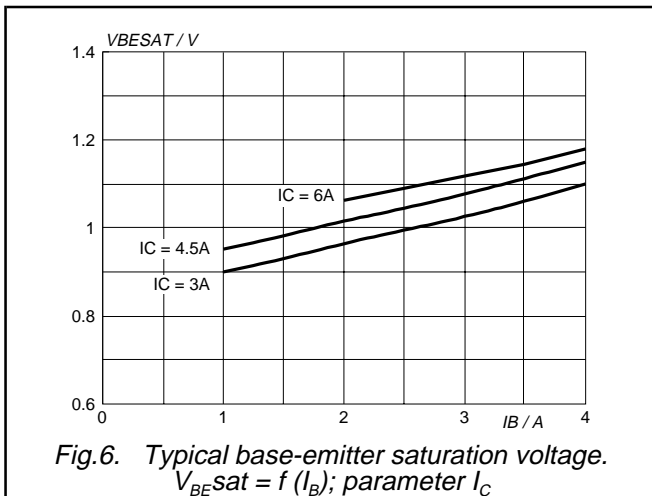
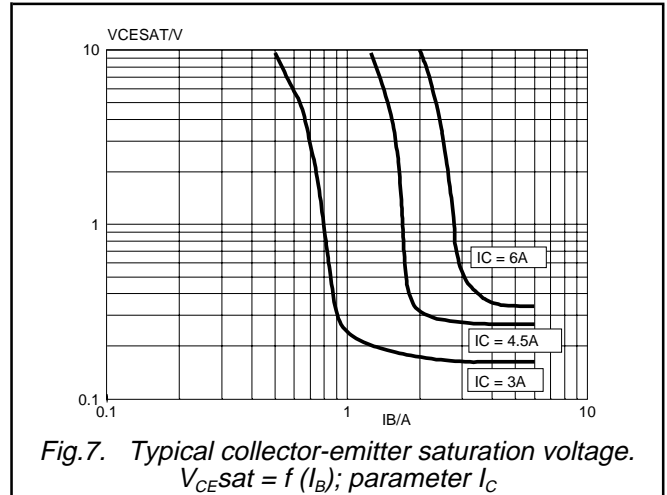
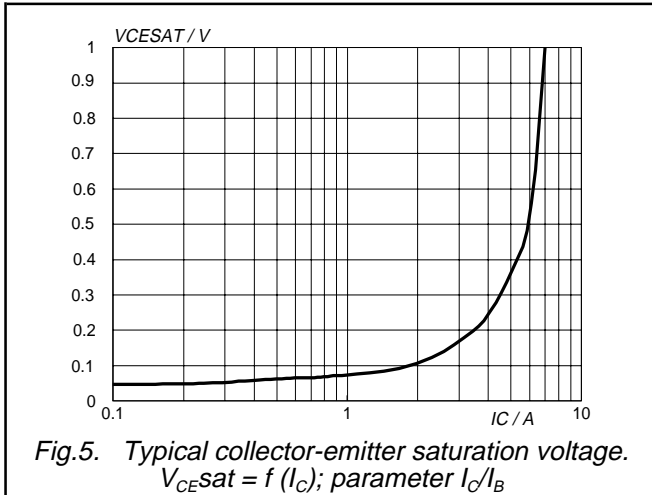

Silicon Diffused Power Transistor

BU508DF

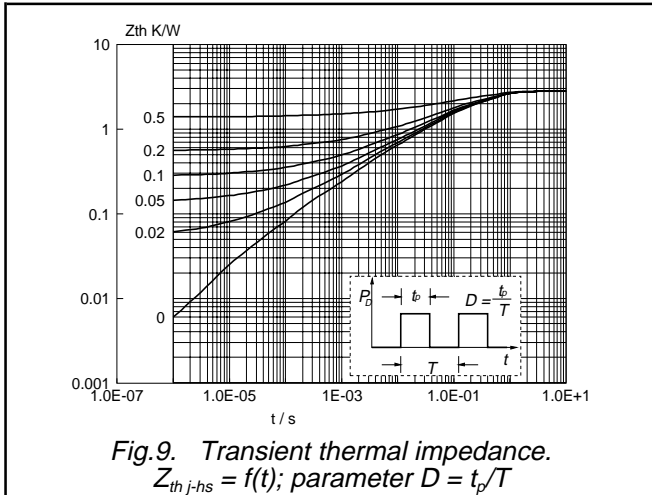

Fig.9. Transient thermal impedance.
 $Z_{th-j-hs} = f(t)$; parameter $D = t_p/T$

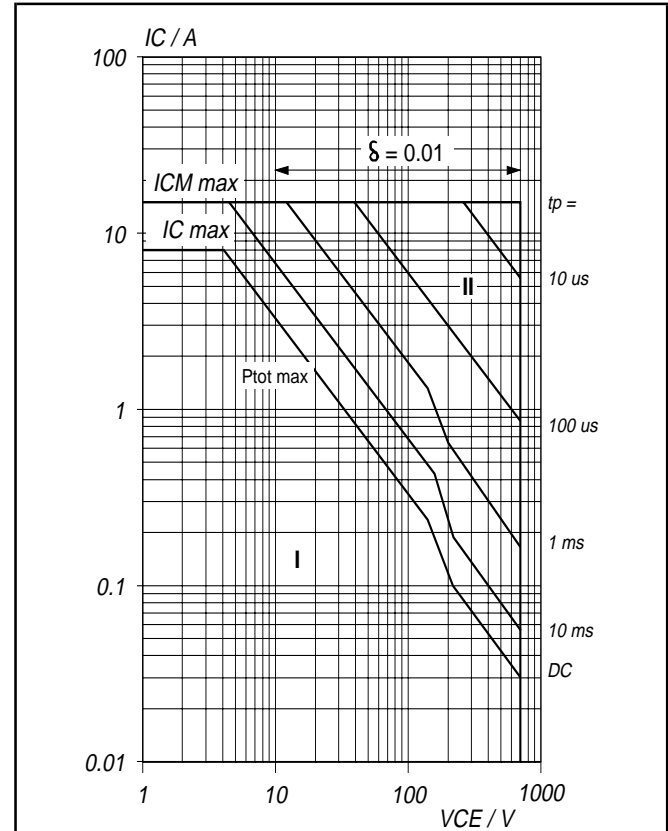

Fig.11. Forward bias safe operating area. $T_{hs} = 25^\circ C$
 I Region of permissible DC operation.
 II Extension for repetitive pulse operation.

NB: Mounted without heatsink compound and 30 ± 5 newton force on the centre of the envelope.

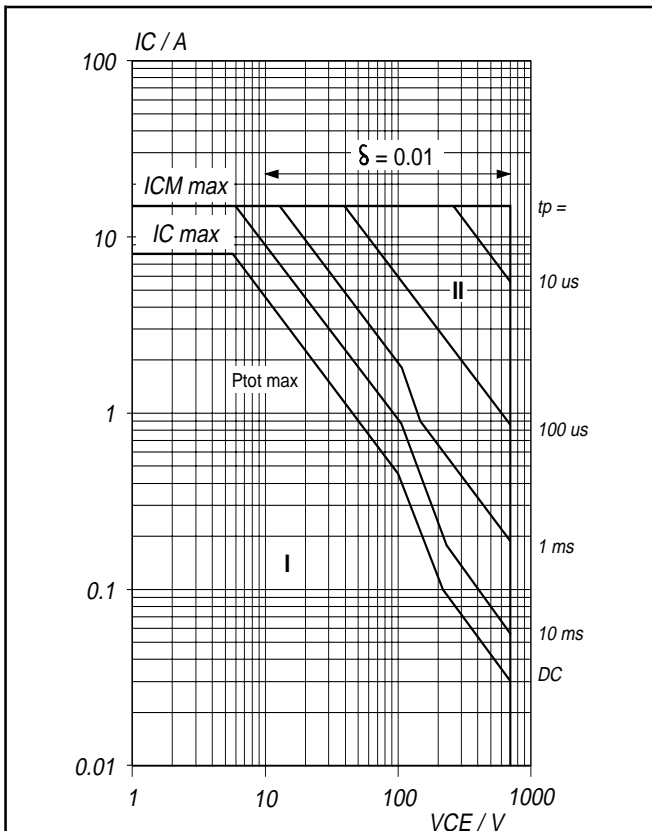

Fig.10. Forward bias safe operating area. $T_{hs} = 25^\circ C$
 I Region of permissible DC operation.
 II Extension for repetitive pulse operation.

NB: Mounted with heatsink compound and 30 ± 5 newton force on the centre of the envelope.

Silicon Diffused Power Transistor

BU508DF

MECHANICAL DATA

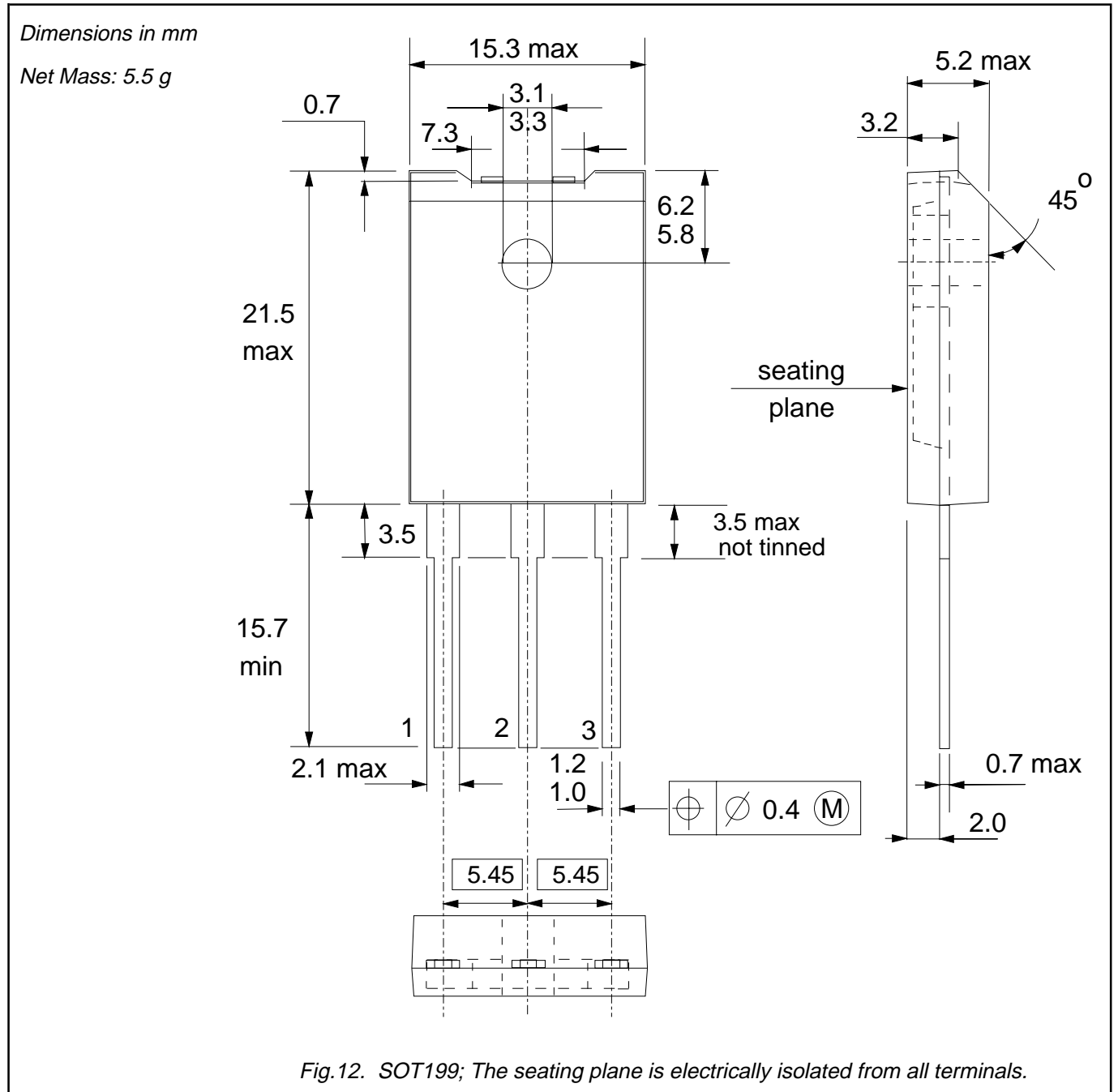

Notes

- 1. Refer to mounting instructions for F-pack envelopes.
- 2. Epoxy meets UL94 V0 at 1/8".

Silicon Diffused Power Transistor

BU508DF

DEFINITIONS

Data sheet status	
Objective specification	This data sheet contains target or goal specifications for product development.
Preliminary specification	This data sheet contains preliminary data; supplementary data may be published later.
Product specification	This data sheet contains final product specifications.
Limiting values	
Limiting values are given in accordance with the Absolute Maximum Rating System (IEC 134). Stress above one or more of the limiting values may cause permanent damage to the device. These are stress ratings only and operation of the device at these or at any other conditions above those given in the Characteristics sections of this specification is not implied. Exposure to limiting values for extended periods may affect device reliability.	
Application information	
Where application information is given, it is advisory and does not form part of the specification.	
© Philips Electronics N.V. 1998	
All rights are reserved. Reproduction in whole or in part is prohibited without the prior written consent of the copyright owner.	
The information presented in this document does not form part of any quotation or contract, it is believed to be accurate and reliable and may be changed without notice. No liability will be accepted by the publisher for any consequence of its use. Publication thereof does not convey nor imply any license under patent or other industrial or intellectual property rights.	

LIFE SUPPORT APPLICATIONS

These products are not designed for use in life support appliances, devices or systems where malfunction of these products can be reasonably expected to result in personal injury. Philips customers using or selling these products for use in such applications do so at their own risk and agree to fully indemnify Philips for any damages resulting from such improper use or sale.