

## 1.25A High Efficiency Switching Regulator

### FEATURES

- Available in MiniDIP, TO-220, and TO-3 Packages
- Wide Input Voltage Range 3V–60V
- Low Quiescent Current—6mA
- Internal 1.25A Switch
- Very Few External Parts Required
- Self-Protected Against Overloads
- Operates in Nearly All Switching Topologies
- Shutdown Mode Draws Only 50 $\mu$ A Supply Current
- Flyback-Regulated Mode has Fully Floating Outputs
- Can be Externally Synchronized

### APPLICATIONS

- Logic Supply 5V @ 2.5A
- 5V Logic to  $\pm$  15V Op Amp Supply
- Offline Converter up to 50W
- Battery Upconverter
- Power Inverter (+ to -) or (- to +)
- Fully Floating Multiple Outputs
- Driver for High Current Supplies

#### USER NOTE:

This data sheet is only intended to provide specifications, graphs, and a general functional description of the LT1072. Application circuits are included to show the capability of the LT1072. A complete design manual (AN-19) should be obtained to assist in developing new designs. This manual contains a comprehensive discussion of both the LT1070 and the external components used with it, as well as complete formulas for calculating the values of these components. The manual can also be used for the LT1072 by factoring in the lower switch current rating.

### DESCRIPTION

The LT1072 is a monolithic high power switching regulator. It can be operated in all standard switching configurations including buck, boost, flyback, forward, inverting and "Cuk". A high current, high efficiency switch is included on the die along with all oscillator, control, and protection circuitry. Integration of all functions allows the LT1072 to be built in a standard 5-pin TO-3 or TO-220 power package as well as the 8-pin miniDIP. This makes it extremely easy to use and provides "bust proof" operation similar to that obtained with 3-pin linear regulators.

The LT1072 operates with supply voltages from 3V to 60V, and draws only 6mA quiescent current. It can deliver load power up to 20 watts with no external power devices. By utilizing current-mode switching techniques, it provides excellent AC and DC load and line regulation.

The LT1072 has many unique features not found even on the vastly more difficult to use low power control chips presently available. It uses adaptive anti-sat switch drive to allow very wide ranging load currents with no loss in efficiency. An externally activated shutdown mode reduces total supply current to 50 $\mu$ A typical for standby operation. Totally isolated and regulated outputs can be generated by using the optional "flyback regulation mode" built into the LT1072, without the need for optocouplers or extra transformer windings.

### TYPICAL APPLICATION

Boost Converter (5V to 12V)

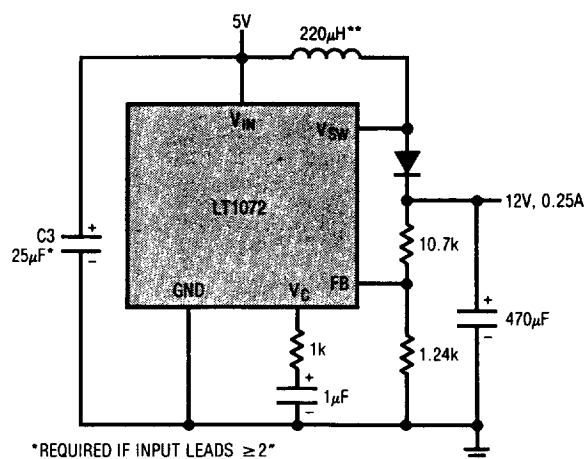

\*REQUIRED IF INPUT LEADS  $\geq 2^\circ$

\*\*PULSE ENGINEERING 52626

Maximum Output Power\*

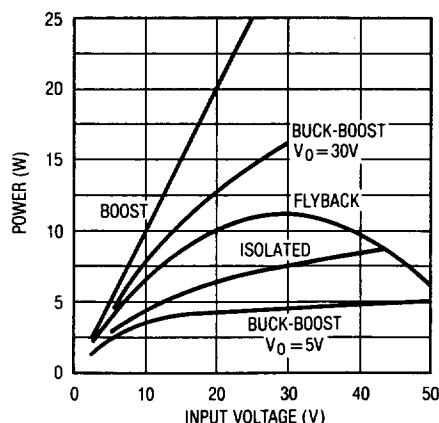

\*ROUGH GUIDE ONLY. BUCK MODE  $P_{OUT} = 1A \times V_{OUT}$ .  
 MINIDIP OUTPUT POWER MAY BE LIMITED BY PACKAGE TEMPERATURE RISE AT HIGH INPUT VOLTAGES OR HIGH DUTY CYCLES.

## ABSOLUTE MAXIMUM RATINGS

Supply Voltage	
LT1072HV (See Note 1)	60V
LT1072 (See Note 1)	40V
Switch Output Voltage	
LT1072HV	75V
LT1072	65V
LT1072S8	60V
Feedback Pin Voltage (Transient, 1ms)	±15V
Operating Junction Temperature Range	
LT1072HVM, LT1072M	-55°C to +150°C
LT1072HVC, LT1072C (Oper.)*	0°C to +100°C
LT1072HVC, LT1072C (Sh. Ckt.)*	0°C to +125°C
Storage Temperature Range	-65°C to +150°C
Lead Temperature (Soldering, 10 sec.)	300°C

\*Includes LT1072S8

**Note 1:** Minimum switch "on" time for the LT1072 in current limit is ≈0.7μsec. This limits the maximum input voltage during short circuit conditions, *in the buck and inverting modes only*, to ≈40V. Normal (unshorted) conditions are not affected. If the LT1072 is being operated in the buck or inverting mode at high input voltages and short circuit conditions are expected, a resistor must be placed in series with the inductor, as follows:

$$\text{The value of the resistor is given by: } R = \frac{(t)(f)(V_{IN}) - V_f}{I_{(LIMIT)}} - R_L$$

t = Minimum "on" time of LT1072 in current limit, ≈0.7μs

f = Operating frequency (40kHz)

V<sub>f</sub> = Forward voltage of external catch diode at I<sub>(LIMIT)</sub>

I<sub>(LIMIT)</sub> = Current limit of LT1072 (2A)

R<sub>L</sub> = Internal series resistance of inductor

## PACKAGE/ORDER INFORMATION

<p>BOTTOM VIEW K PACKAGE 4-LEAD TO-3 METAL CAN</p> <p>LT1072MK, LT1072HVMK: T<sub>JMAX</sub> = 150°C, θ<sub>JC</sub> = 8°C/W, θ<sub>JA</sub> = 35°C/W LT1072CK, LT1072HVCK: T<sub>JMAX</sub> = 100°C, θ<sub>JC</sub> = 8°C/W, θ<sub>JA</sub> = 35°C/W</p>	<p>ORDER PART NUMBER</p> <p>LT1072HVMK LT1072MK LT1072HVCK LT1072CK</p>
<p>FRONT VIEW T PACKAGE 5-LEAD TO-220</p> <p>T<sub>JMAX</sub> = 100°C/W, θ<sub>JC</sub> = 8°C/W, θ<sub>JA</sub> = 50°C/W</p>	<p>LT1072HVCT LT1072CT</p>
<p>TOP VIEW (N PACKAGE) TOP VIEW (J PACKAGE) TOP VIEW (S PACKAGE)</p> <p>N PACKAGE: 8-LEAD PLASTIC DIP, T<sub>JMAX</sub> = 150°C, θ<sub>JA</sub> = 100°C/W (J) J PACKAGE: 8-LEAD CERAMIC DIP, T<sub>JMAX</sub> = 100°C, θ<sub>JA</sub> = 130°C/W (N) S PACKAGE: 8-LEAD PLASTIC SOIC, T<sub>JMAX</sub> = 100°C, θ<sub>JA</sub> = 130°C/W</p>	<p>LT1072MJ8 LT1072CJ8 LT1072CN8 LT1072CS8</p>
<p>TOP VIEW (S PACKAGE) 16-LEAD PLASTIC SOL</p> <p>T<sub>JMAX</sub> = 100°C, θ<sub>JA</sub> = 150°C/W</p>	<p>LT1072CS</p>

All Thermal Information is based on continuous operation.

\*T<sub>JMAX</sub> = 125°C for intermittent fault conditions.

Consult factory for industrial grade parts.

4

## ELECTRICAL CHARACTERISTICS Unless otherwise specified, V<sub>IN</sub> = 15V, V<sub>C</sub> = 0.5V, V<sub>FB</sub> = V<sub>REF</sub>, output pin open.

SYMBOL	PARAMETER	CONDITIONS	MIN	TYP	MAX	UNITS
V <sub>REF</sub>	Reference Voltage	Measured at Feedback Pin V <sub>C</sub> = 0.8V	1.224	1.244	1.264	V
			1.214	1.244	1.274	V
I <sub>B</sub>	Feedback Input Current	V <sub>FB</sub> = V <sub>REF</sub>	350	750	1100	nA
						nA
g <sub>m</sub>	Error Amplifier Transconductance	ΔI <sub>C</sub> = ±25μA	3000	4400	6000	μmho
			2400	7000		μmho
	Error Amplifier Source or Sink Current	V <sub>C</sub> = 1.5V	150	200	350	μA
			120	400		μA
	Error Amplifier Clamp Voltage	Hi Clamp, V <sub>FB</sub> = 1V Lo Clamp, V <sub>FB</sub> = 1.5V	1.8		2.3	V
			0.25	0.38	0.52	V
A <sub>V</sub>	Error Amplifier Voltage Gain	0.9V ≤ V <sub>C</sub> ≤ 1.4V	500	800		V/V
	Minimum Input Voltage		2.6	3.0		V
I <sub>Q</sub>	Supply Current	3V ≤ V <sub>IN</sub> ≤ V <sub>MAX</sub> , V <sub>C</sub> = 0.6V	6	9		mA
	Control Pin Threshold	Duty Cycle = 0	0.8	0.9	1.08	V
			0.6	1.25		V

**ELECTRICAL CHARACTERISTICS** Unless otherwise specified,  $V_{IN} = 15V$ ,  $V_C = 0.5V$ ,  $V_{FB} = V_{REF}$ , output pin open.

SYMBOL	PARAMETER	CONDITIONS	MIN	TYP	MAX	UNITS
	Normal/Flyback Threshold on Feedback Pin		0.4	0.45	0.54	V
$V_{FB}$	Flyback Reference Voltage	$I_{FB} = 50\mu A$	15 14	16.3	17.6 18	V V
	Change in Flyback Reference Voltage	$0.05 \leq I_{FB} \leq 1mA$	4.5	6.8	8.5	V
	Flyback Reference Voltage Line Regulation	$I_{FB} = 50\mu A$ $3V \leq V_{IN} \leq V_{MAX}$ (Note 3)		0.01	0.03	%/V %/V
	Flyback Amplifier Transconductance (gm)	$\Delta I_C = \pm 10\mu A$	150	300	500	$\mu mho$
	Flyback Amplifier Source and Sink Current	$V_C = 0.6V$ Source $I_{FB} = 50\mu A$ Sink	15 25	32 40	70 70	$\mu A$ $\mu A$
BV	Output Switch Breakdown Voltage	$3V \leq V_{IN} \leq V_{MAX}$ $I_{SW} = 1.5mA$				V V V
		LT1072	65	90		V
		LT1072HV	75	90		V
		LT1072S8	60	80		V
$V_{SAT}$	Output Switch ON Resistance (Note 1)	$I_{SW} = 1A$		0.6	1	$\Omega$
	Control Voltage to Switch Current Transconductance			2		A/V
$I_{LIM}$	Switch Current Limit	Duty Cycle $\leq 50\%$ $T_J \geq 25^\circ C$ Duty Cycle $\leq 50\%$ $T_J < 25^\circ C$ Duty Cycle = 80% (Note 2)	1.25 1.25 1		3 3.5 2.5	A A A
$\frac{\Delta I_{IN}}{\Delta I_{SW}}$	Supply Current Increase During Switch ON Time			25	35	mA/A
f	Switching Frequency		35 33	40	45 47	kHz kHz
DC (max)	Maximum Switch Duty Cycle		90	92	97	%
	Flyback Sense Delay Time			1.5		$\mu s$
	Shutdown Mode Supply Current	$3V \leq V_{IN} \leq V_{MAX}$ $V_C = 0.05V$		100	250	$\mu A$
	Shutdown Mode Threshold Voltage	$3V \leq V_{IN} \leq V_{MAX}$	100 50	150	250 300	mV mV

The ● denotes the specifications which apply over the full operating temperature range.

**Note 1:** Measured with  $V_C$  in hi clamp,  $V_{FB} = 0.8V$ .

**Note 2:** For duty cycles (DC) between 50% and 80%, minimum guaranteed switch current is given by  $I_{LIM} = 0.833(2 - DC)$ .

**Note 3:**  $V_{MAX} = 55V$  for HV grade to avoid switch breakdown.

**TYPICAL PERFORMANCE CHARACTERISTICS**

Switch Current Limit vs Duty Cycle

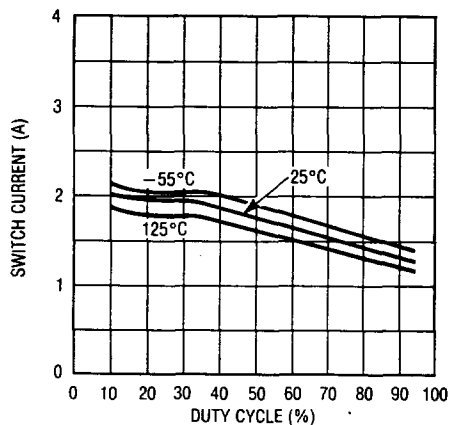

Maximum Duty Cycle

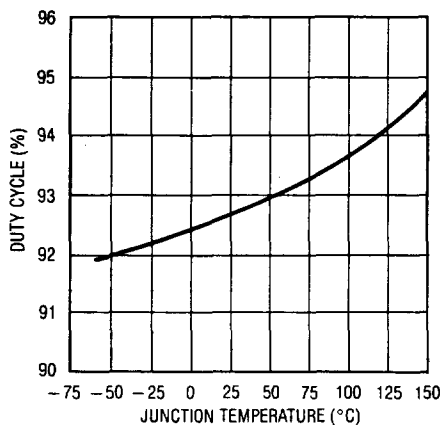

Flyback Blanking Time

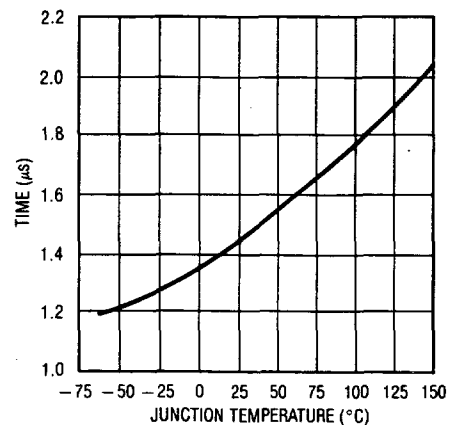

# TYPICAL PERFORMANCE CHARACTERISTICS

**Minimum Input Voltage**

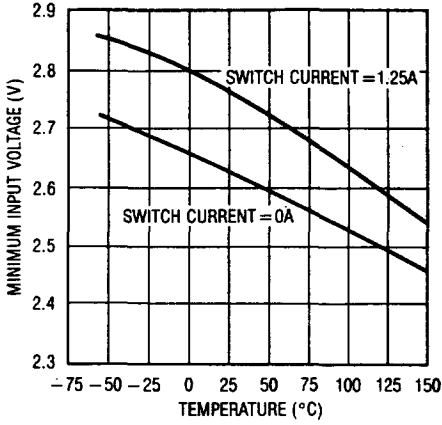

**Switch Saturation Voltage**

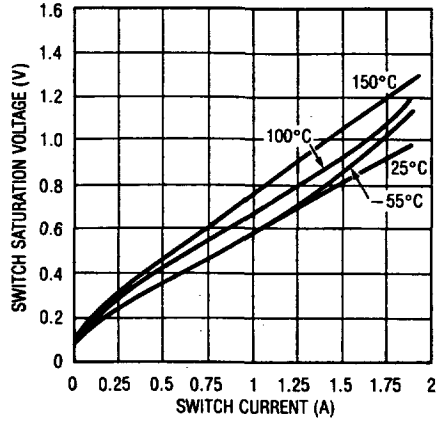

**Isolated Mode Flyback Reference Voltage**

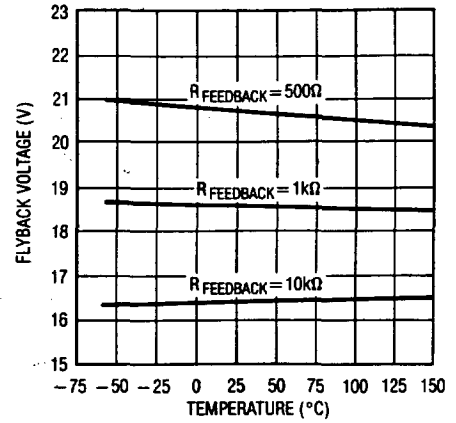

**Line Regulation**

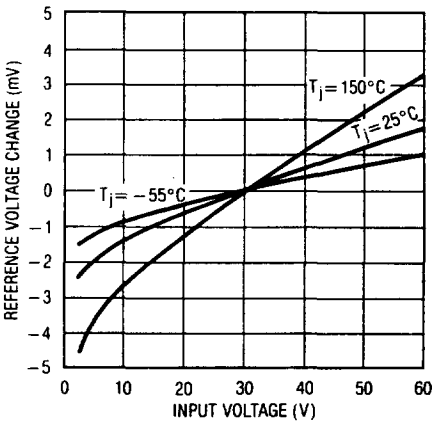

**Reference Voltage and Switching Frequency vs Temperature**

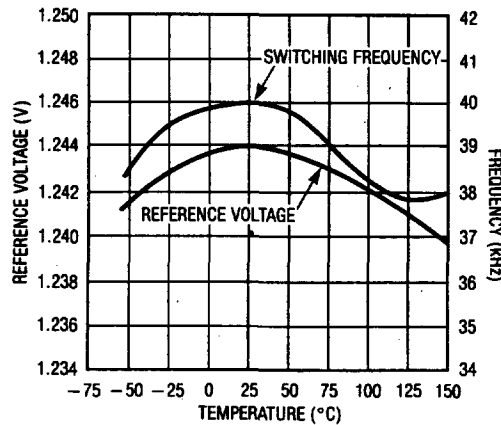

**Feedback Bias Current vs Temperature**

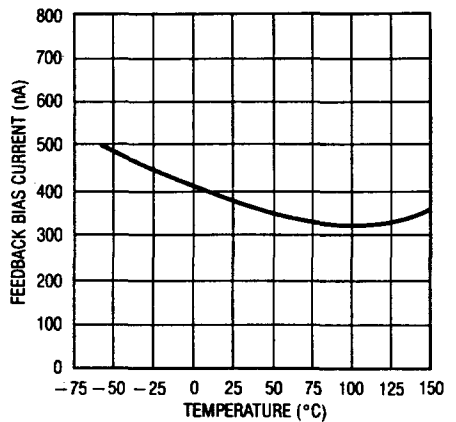

4

**Driver Current\* vs Switch Current**

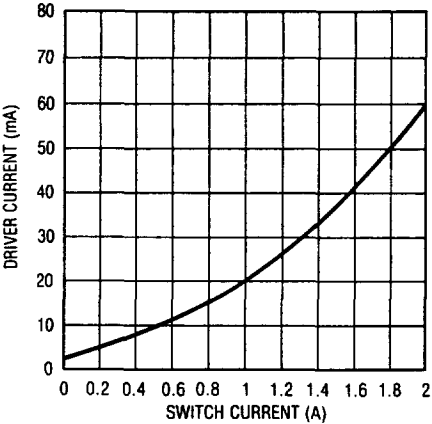

**Supply Current vs Input Voltage\***

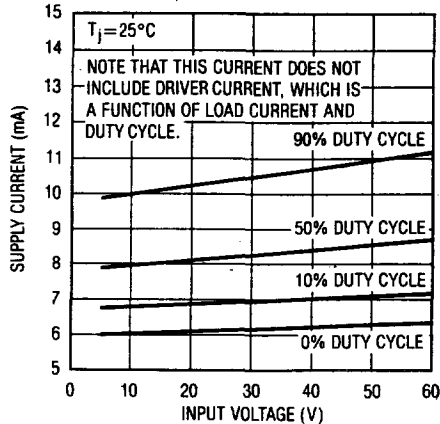

**Supply Current vs Supply Voltage (Shutdown Mode)**

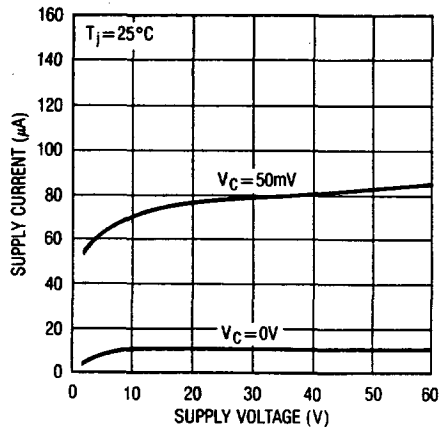

\*AVERAGE LT1072 POWER SUPPLY CURRENT IS FOUND BY MULTIPLYING DRIVER CURRENT BY DUTY CYCLE, THEN ADDING QUIESCENT CURRENT.

\*UNDER VERY LOW OUTPUT CURRENT CONDITIONS, DUTY CYCLE FOR MOST CIRCUITS WILL APPROACH 10% OR LESS.

# TYPICAL PERFORMANCE CHARACTERISTICS

**Normal/Flyback Mode Threshold on Feedback Pin**

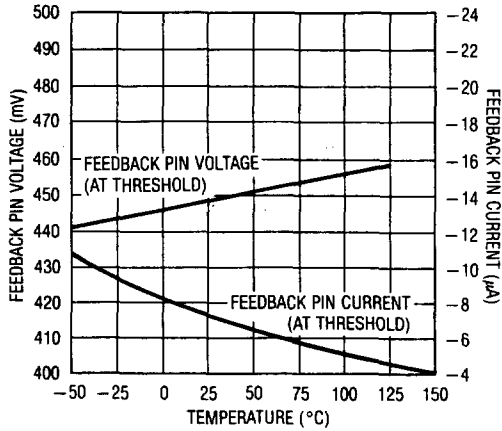

**Shutdown Mode Supply Current**

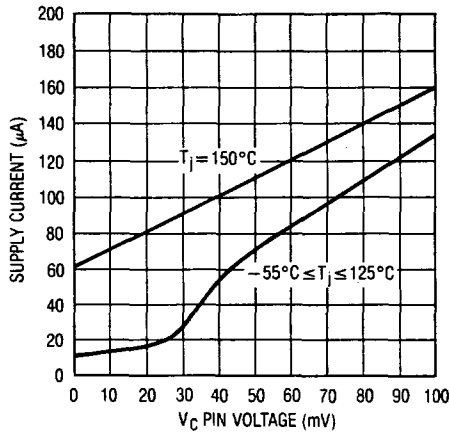

**Error Amplifier Transconductance**

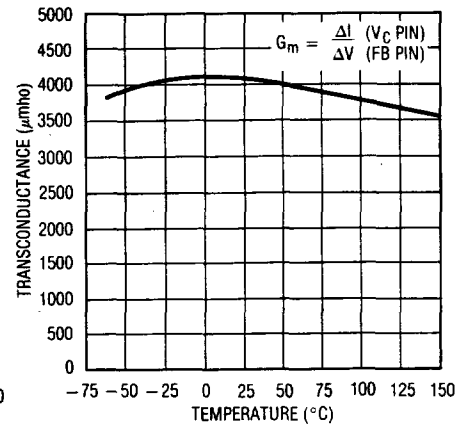

**Shutdown Thresholds**

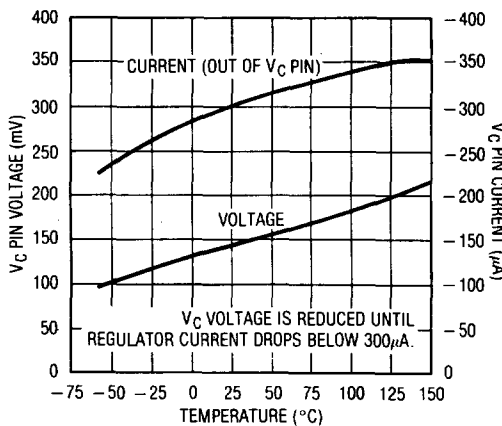

**Idle Supply Current vs Temperature**

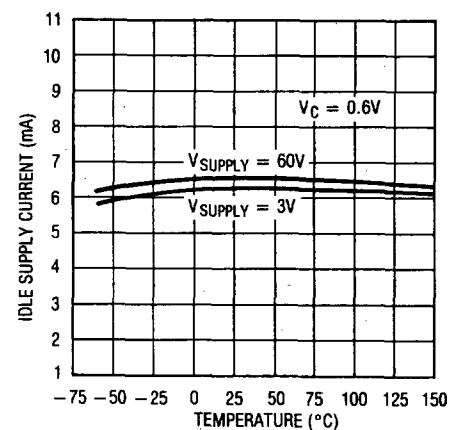

**Feedback Pin Clamp Voltage**

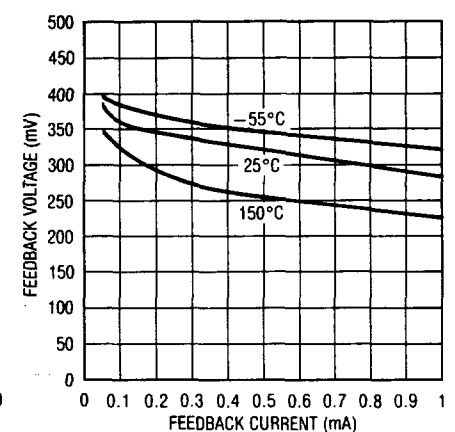

**Transconductance of Error Amplifier**

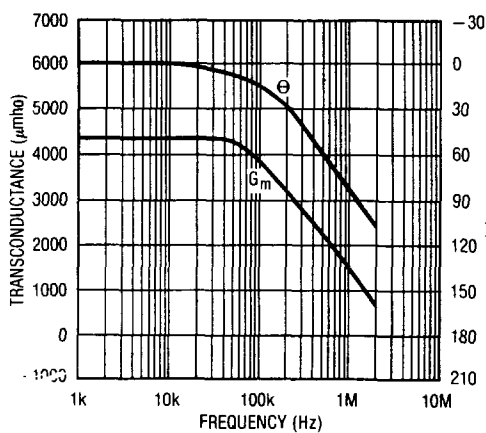

**Vc Pin Characteristics**

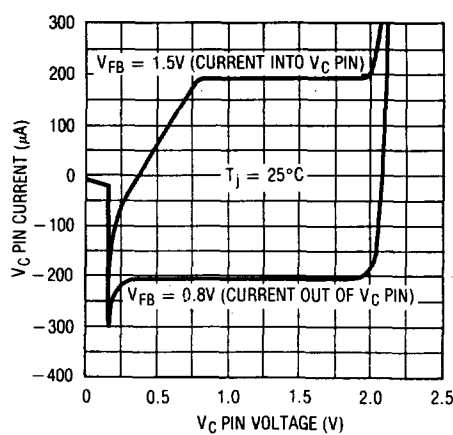

**Switch "Off" Characteristics**

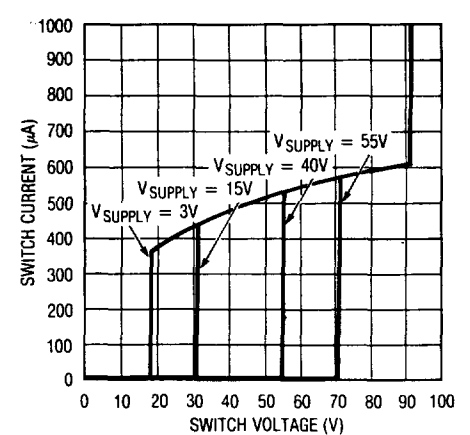

## BLOCK DIAGRAM

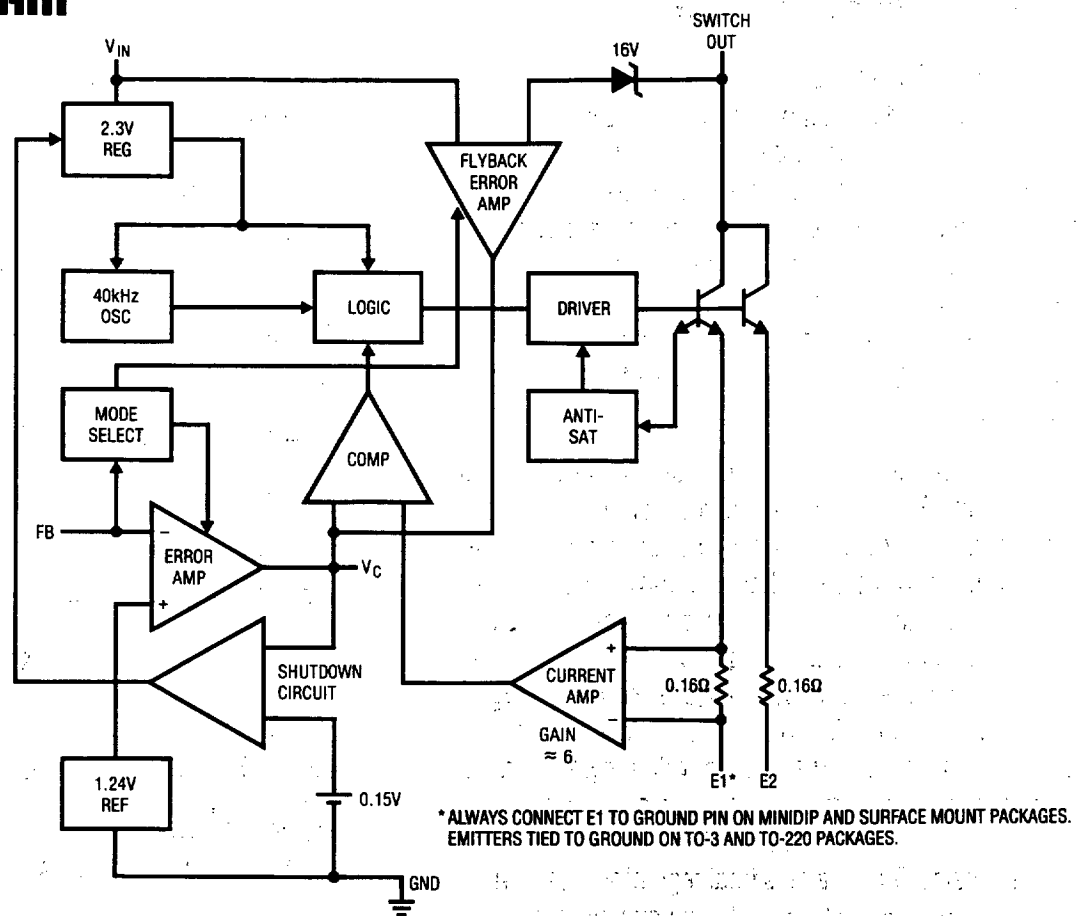

4

## LT1072 OPERATION

The LT1072 is a current mode switcher. This means that switch duty cycle is directly controlled by switch current rather than by output voltage. Referring to the block diagram, the switch is turned "on" at the start of each oscillator cycle. It is turned "off" when switch current reaches a predetermined level. Control of output voltage is obtained by using the output of a voltage sensing error amplifier to set current trip level. This technique has several advantages. First, it has immediate response to input voltage variations, unlike ordinary switchers which have notoriously poor line transient response. Second, it reduces the 90° phase shift at midfrequencies in the energy storage inductor. This greatly simplifies closed loop frequency compensation under widely varying input voltage or output load conditions. Finally, it allows simple pulse-by-pulse current limiting to provide maximum switch protection under output overload or short conditions. A low-dropout internal regulator provides a 2.3V supply for all internal cir-

cuitry on the LT1072. This low-dropout design allows input voltage to vary from 3V to 60V with virtually no change in device performance. A 40kHz oscillator is the basic clock for all internal timing. It turns "on" the output switch via the logic and driver circuitry. Special adaptive antisat circuitry detects onset of saturation in the power switch and adjusts driver current instantaneously to limit switch saturation. This minimizes driver dissipation and provides very rapid turn-off of the switch.

A 1.2V bandgap reference biases the positive input of the error amplifier. The negative input is brought out for output voltage sensing. This feedback pin has a second function; when pulled low with an external resistor, it programs the LT1072 to disconnect the main error amplifier output and connects the output of the flyback amplifier to the comparator input. The LT1072 will then regulate the value of the flyback pulse with respect to the supply voltage. This flyback pulse is

## LT1072 OPERATION

directly proportional to output voltage in the traditional transformer coupled flyback topology regulator. By regulating the amplitude of the flyback pulse, the output voltage can be regulated with no direct connection between input and output. The output is fully floating up to the breakdown voltage of the transformer windings. Multiple floating outputs are easily obtained with additional windings. A special delay network inside the LT1072 ignores the leakage inductance spike at the leading edge of the flyback pulse to improve output regulation.

The error signal developed at the comparator input is brought out externally. This pin ( $V_C$ ) has four different functions. It is used for frequency compensation, current limit adjustment, soft starting, and total regulator shutdown. During normal regulator operation this pin sits at a voltage between 0.9V (low output current) and 2.0V (high output current). The error amplifiers are current output (gm) types, so this voltage can be externally clamped for adjusting current limit. Likewise, a capacitor coupled external clamp will provide soft start. Switch duty cycle goes to zero if the  $V_C$  pin is pulled to ground through a diode, placing the LT1072 in an idle mode. Pulling the  $V_C$  pin below 0.15V causes total regulator shutdown, with only 50 $\mu$ A supply current for shutdown circuitry biasing. See AN-19 for full application details.

### Extra Pins on the MiniDIP and Surface Mount Packages

The 8 and 16-pin versions of the LT1072 have the emitters of the power transistor brought out separately from the ground pin. This eliminates errors due to ground pin voltage drops and allows the user to reduce switch current limit 2:1 by leaving the second emitter (E2) disconnected. The first emitter (E1) should always be connected to the ground pin. Note that switch "on" resistance doubles when E2 is left open, so efficiency will suffer somewhat when switch currents exceed 100mA. Also, note that chip dissipation will actually *increase* with E2 open during normal load operation, even though dissipation in current limit mode will *decrease*. See "Thermal Considerations."

### Thermal Considerations When Using Small Packages

The low supply current and high switch efficiency of the LT1072 allow it to be used without a heat sink in most applications when the TO-220 or TO-3 package is selected.

These packages are rated at 50°C/W and 35°C/W respectively. The small packages, however, are rated at greater than 100°C/W. Care should be taken with these packages to ensure that the worse case input voltage and load current conditions do not cause excessive die temperatures. The following formulas can be used as a rough guide to calculate LT1072 power dissipation. For more details, the reader is referred to Application Note 19 (AN19), "Efficiency Calculations" section.

Average supply current (including driver current) is:

$$I_{IN} \approx 6\text{mA} + I_{SW}(0.004 + DC/40)$$

$I_{SW}$  = switch current

DC = switch duty cycle

Switch power dissipation is given by:

$$P_{SW} = (I_{SW})^2 \cdot R_{SW} \cdot DC$$

$R_{SW}$  = LT1072 switch "on" resistance (1 $\Omega$  maximum)

Total power dissipation is the sum of supply current times input voltage plus switch power:

$$P_{TOT} = (I_{IN})(V_{IN}) + P_{SW}$$

In a typical example, using a boost convertor to generate +12V@0.12A from a +5V input, duty cycle is approximately 60%, and switch current is about 0.65A, yielding:

$$I_{IN} = 6\text{mA} + 0.65(0.004 + DC/40) = 18\text{mA}$$

$$P_{SW} = (0.65)^2 \cdot 1\Omega \cdot (0.6) = 0.25\text{W}$$

$$P_{TOT} = (5\text{V})(0.018\text{A}) + 0.25 = 0.34\text{W}$$

Temperature rise in a plastic miniDIP would be 130°C/W times 0.34W, or approximately 44°C. The maximum ambient temperature would be limited to 100°C (commercial temperature limit) minus 44°C, or 56°C.

In most applications, full load current is used to calculate die temperature. However, if overload conditions must also be accounted for, four approaches are possible. First, if loss of regulated output is acceptable under overload conditions, the internal *thermal limit* of the LT1072 will protect the die in most applications by shutting off switch

## LT1072 OPERATION

current. *Thermal limit is not a tested parameter*, however, and should be considered only for non-critical applications with temporary overloads. A second approach is to use the larger TO-220 (T) or TO-3 (K) package which, even without a heat sink, may limit die temperatures to safe levels under overload conditions. In critical situations, heat sinking of these packages is required; especially if overload conditions must be tolerated for extended periods of time.

The third approach for lower current applications is to leave the second switch emitter open. This increases switch "on" resistance by 2:1, but reduces switch current limit by 2:1 also, resulting in a net 2:1 reduction in  $I^2R$  switch dissipation under current limit conditions.

The fourth approach is to clamp the  $V_C$  pin to a voltage less than its internal clamp level of 2V. The LT1072 switch current limit is zero at approximately 1V on the  $V_C$  pin and 2A at 2V on the  $V_C$  pin. Peak switch current can be externally clamped between these two levels with a diode. See AN-19 for details.

### LT1072 Synchronizing

The LT1072 can be externally synchronized in the frequency range of 48kHz to 70kHz. This is accomplished as shown in the accompanying figures. Synchronizing occurs

when the  $V_C$  pin is pulled to ground with an external transistor. To avoid disturbing the DC characteristics of the internal error amplifier, the width of the synchronizing pulse should be under  $1\mu s$ . C2 sets the pulse width at  $\approx 0.35\mu s$ . The effect of a synchronizing pulse on the LT1072 amplifier offset can be calculated from:

$$\Delta V_{OS} = \frac{\left(\frac{KT}{q}\right) (t_s) (f_s) \left(I_C + \frac{V_C}{R_3}\right)}{I_C}$$

$$\frac{KT}{q} = 26mV @ 25^\circ C$$

$t_s$  = pulse width

$f_s$  = pulse frequency

$I_C$  = LT1072  $V_C$  source current ( $\approx 200\mu A$ )

$V_C$  = LT1072 operating  $V_C$  voltage (1V-2V)

$R_3$  = resistor used to set mid-frequency "zero" in LT1072 frequency compensation network.

With  $t_s = 0.35\mu s$ ,  $f_s = 50kHz$ ,  $V_C = 1.5V$ , and  $R_3 = 2K\Omega$ , offset voltage shift is  $\approx 2.2mV$ . This is not particularly bothersome, but note that high offsets could result if  $R_3$  were reduced to a much lower value. Also, the synchronizing transistor must sink higher currents with low values of  $R_3$ , so larger drives may have to be used. The transistor must be capable of pulling the  $V_C$  pin to within 200mV of ground to ensure synchronizing.

Synchronizing with Bipolar Transistor

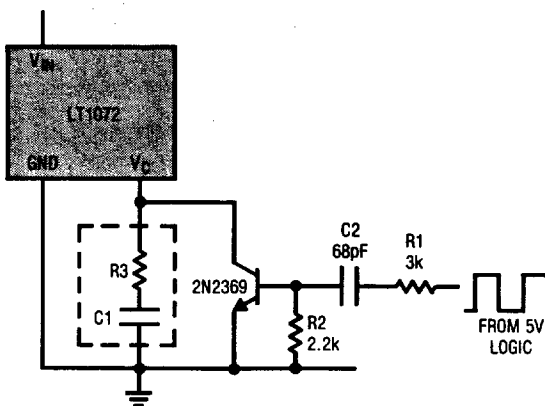

Synchronizing with MOS Transistor

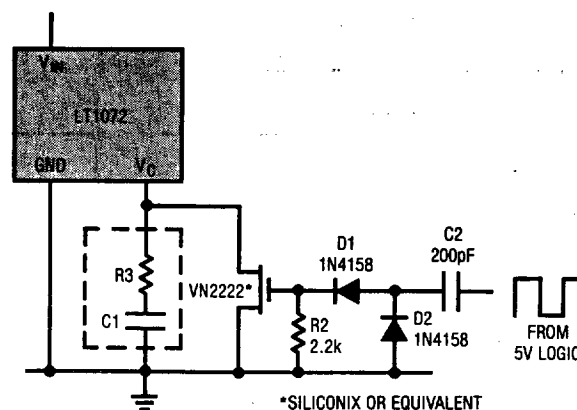



TYPICAL APPLICATIONS

Totally Isolated Converter

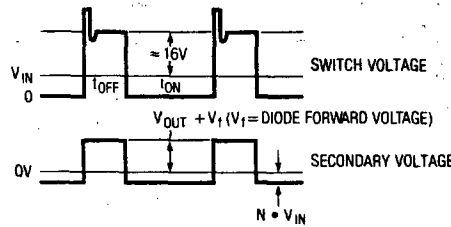
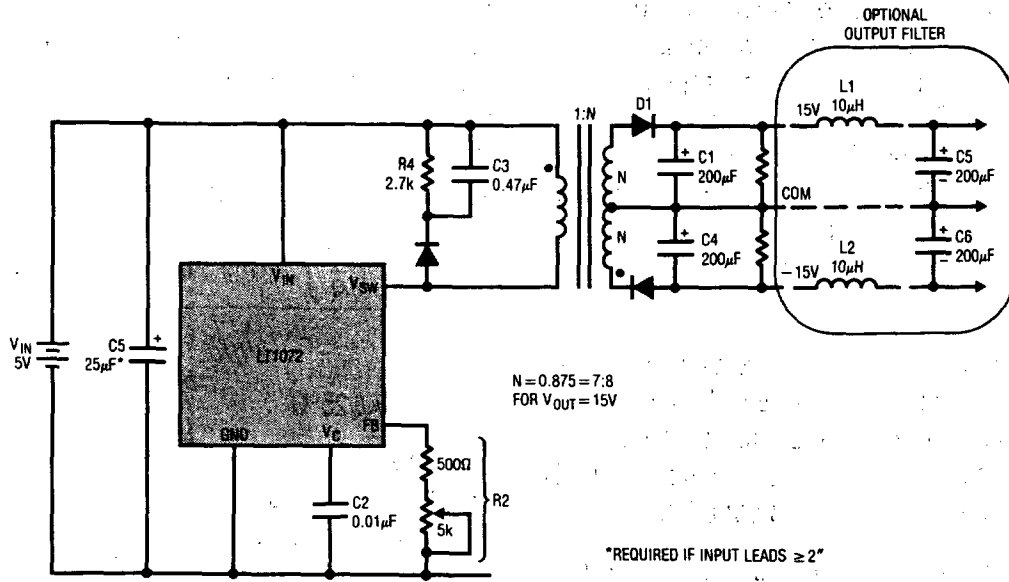

Flyback Converter

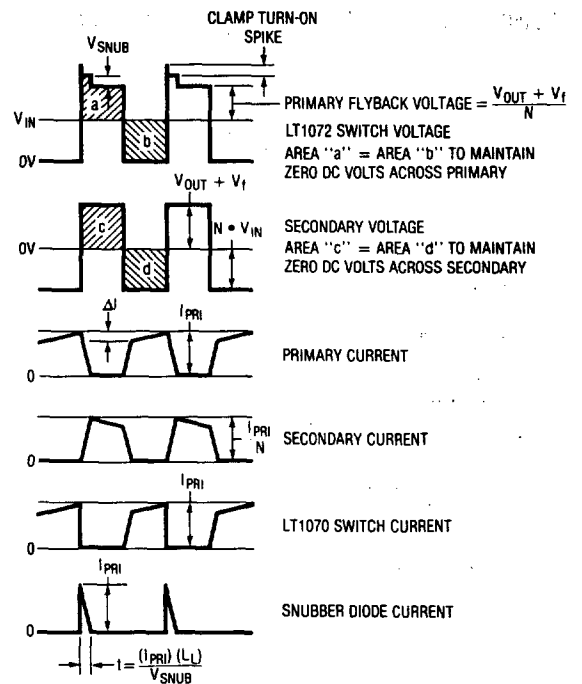
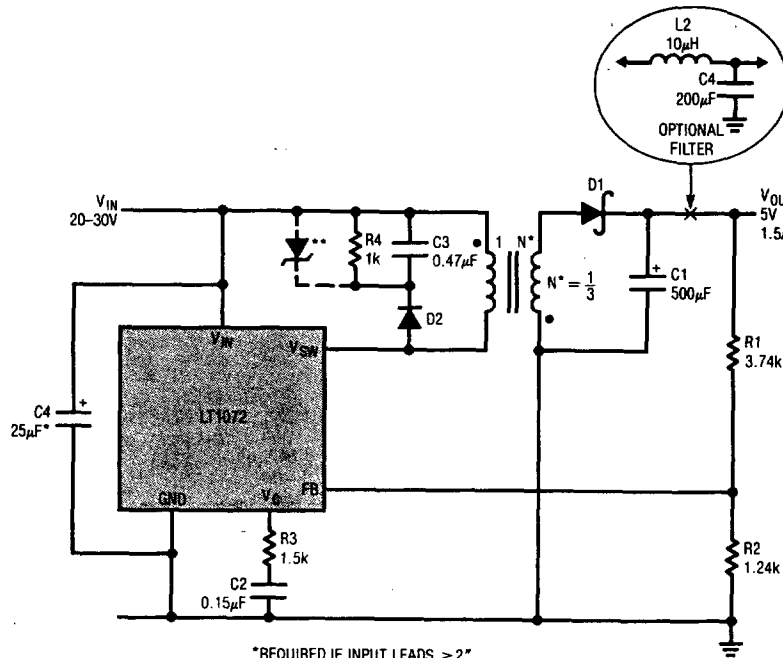

# TYPICAL APPLICATIONS

Negative to Positive Buck-Boost Converter

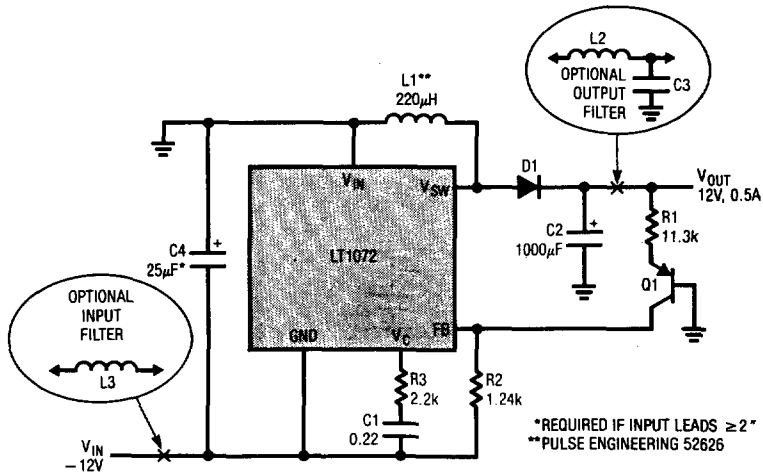

External Current Limit

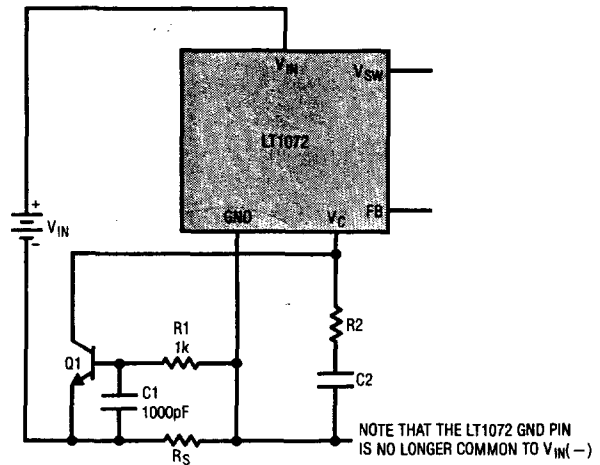

Positive to Negative Buck-Boost Converter

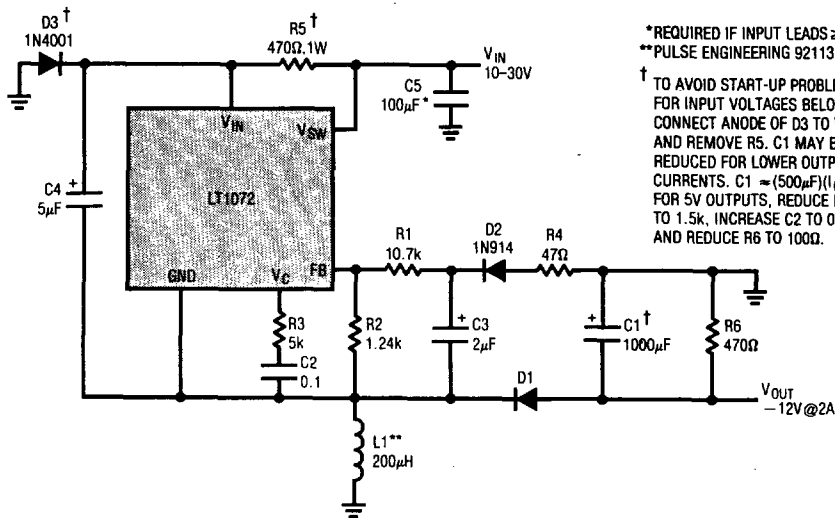

External Current Limit

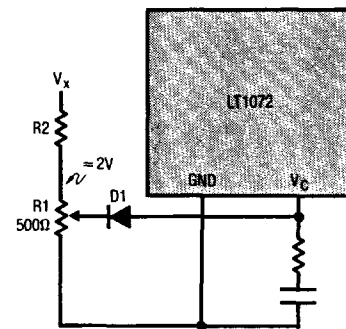

Voltage Boosted Boost Converter

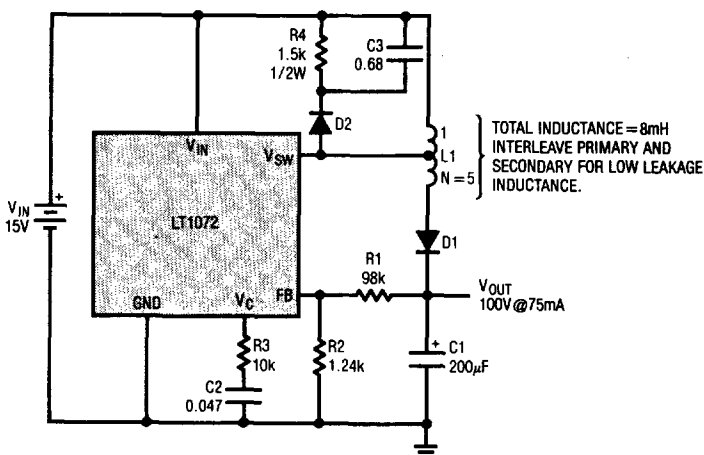

Driving High Voltage FET (for Offline Applications, See AN-25)

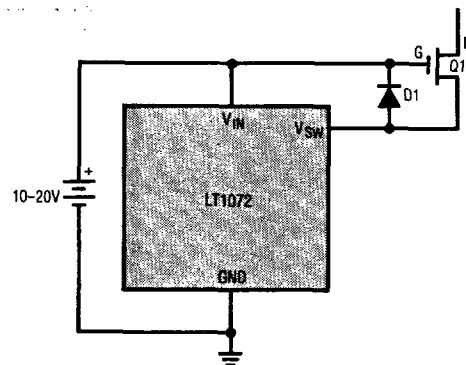

**TYPICAL APPLICATIONS**

**Negative Buck Converter**

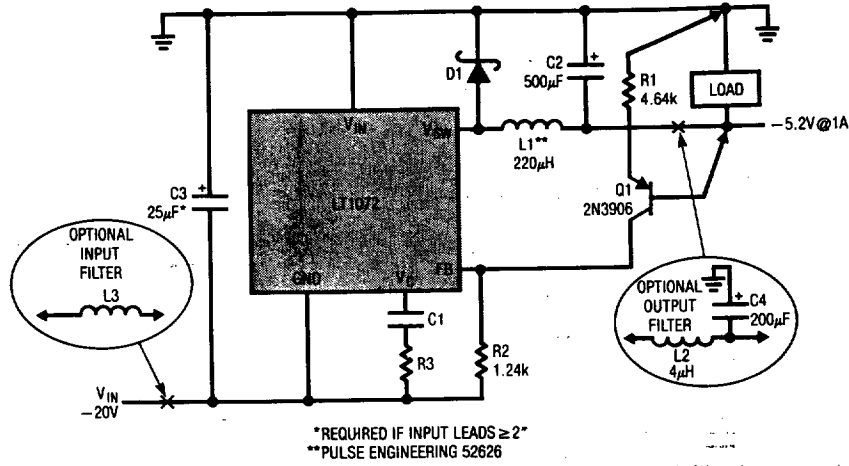

**Positive Buck Converter**

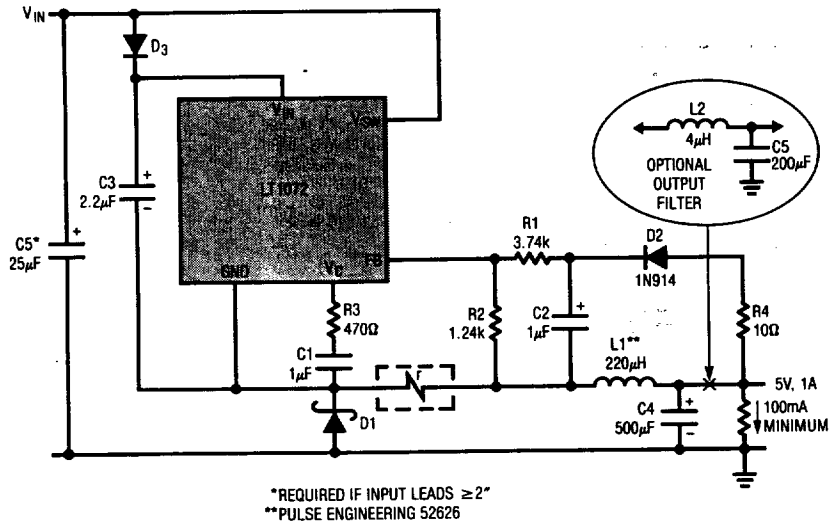

**Negative Boost Regulator**

