

MOS FIELD EFFECT POWER TRANSISTOR 2SK612

FAST SWITCHING N-CHANNEL SILICON POWER MOS FET INDUSTRIAL USE

PACKAGE DIMENSIONS (Unit: mm)

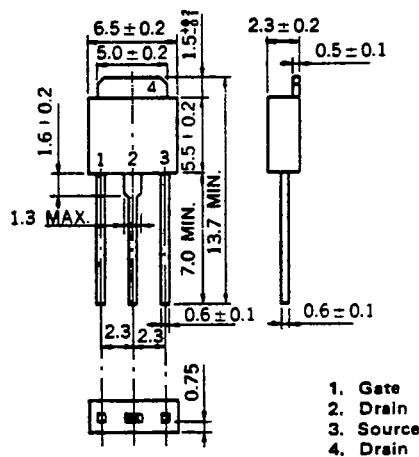

FEATURES

- Suitable for switching power supplies, actuator controls, and pulse circuits.
- Low $R_{DS(on)}$
- No second breakdown
- 4 V Gate Drive — Logic level —

ABSOLUTE MAXIMUM RATINGS ($T_a = 25^\circ\text{C}$)

Drain to Source Voltage	V_{DSS}	100	V
Gate to Source Voltage	V_{GSS}	±20	V
Continuous Drain Current	$I_{D(DC)}$	±2	A
Peak Drain Current	$I_{D(pulse)}$ *	±8	A
Total Power Dissipation	P_T **	20	W
Channel Temperature	T_{ch}	150	°C
Storage Temperature	T_{stg}	-55 to +150	°C

* $PW \leq 10$ ms, Duty Cycle ≤ 50 %

** $T_c = 25^\circ\text{C}$

ELECTRICAL CHARACTERISTICS ($T_a = 25^\circ\text{C}$)

CHARACTERISTIC	SYMBOL	MIN.	TYP.	MAX.	UNIT	TEST CONDITIONS
Drain Leakage Current	I_{DSS}			10	μA	$V_{DS} = 80\text{ V}, V_{GS} = 0$
Gate to Source Leakage Current	I_{GSS}			±100	nA	$V_{GS} = \pm 15\text{ V}, V_{DS} = 0$
Gate to Source Cutoff Voltage	$V_{GS(off)}$	0.8		3.0	V	$V_{DS} = 10\text{ V}, I_D = 1\text{ mA}$
Forward Transfer Admittance	$ y_{fs} $	1.0			S	$V_{DS} = 10\text{ V}, I_D = 1\text{ A}$
Drain to Source On-State Resistance	$R_{DS(on)}$		0.3	0.45	Ω	$V_{GS} = 10\text{ V}, I_D = 1\text{ A}$
Drain to Source On-State Resistance	$R_{DS(on)}$		0.35	0.6	Ω	$V_{GS} = 4\text{ V}, I_D = 0.8\text{ A}$
Input Capacitance	C_{iss}		500		pF	$V_{DS} = 10\text{ V}, V_{GS} = 0$ $f = 1\text{ MHz}$
Output Capacitance	C_{oss}		120		pF	
Reverse Transfer Capacitance	C_{rss}		30		pF	
Turn-On Delay Time	$t_{d(on)}$		10		ns	$I_D = 1\text{ A}, V_{CC} = 50\text{ V}$ $V_{GS(on)} = 10\text{ V}$ $R_L = 50\ \Omega$ $R_{in} = 10\ \Omega$
Rise Time	t_r		20		ns	
Turn-Off Delay Time	$t_{d(off)}$		80		ns	
Fall Time	t_f		20		ns	

TURN-ON AND TURN-OFF TIME TEST CIRCUIT

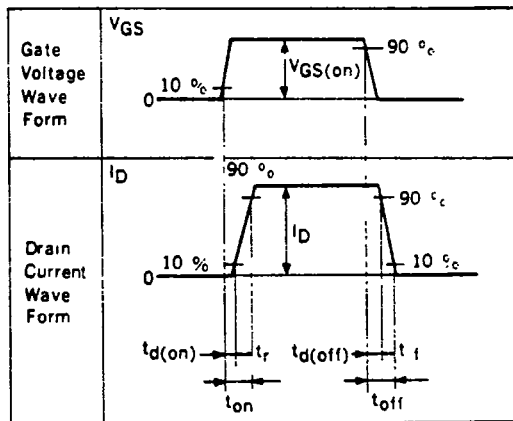
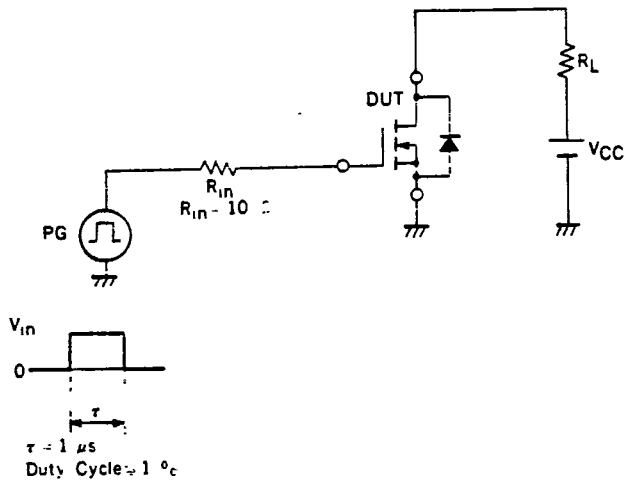

DERATING FACTOR OF FORWARD BIAS SAFE OPERATING AREA

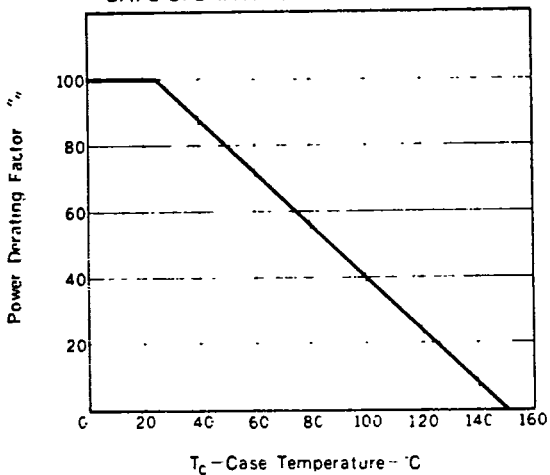

FORWARD BIAS SAFE OPERATING AREA

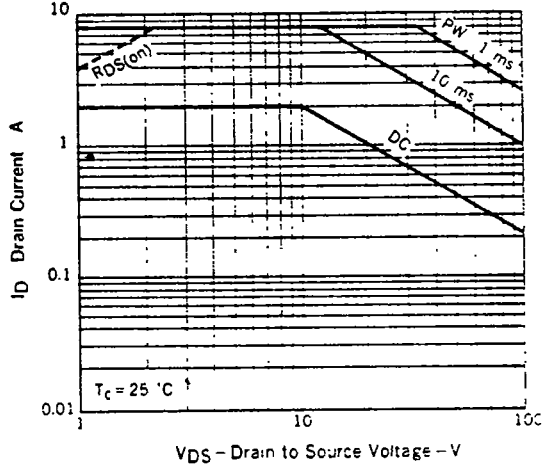

TOTAL POWER DISSIPATION vs. CASE TEMPERATURE

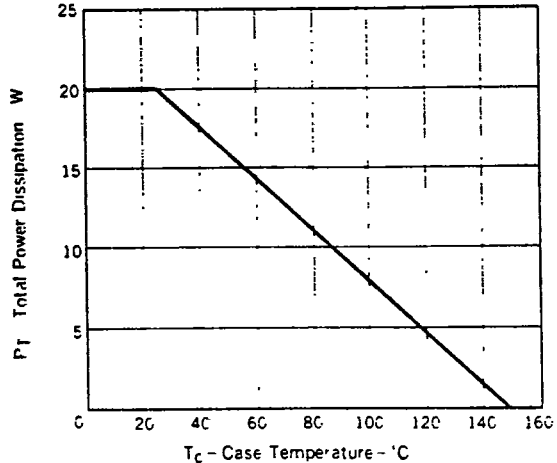

DRAIN CURRENT vs. DRAIN TO SOURCE VOLTAGE

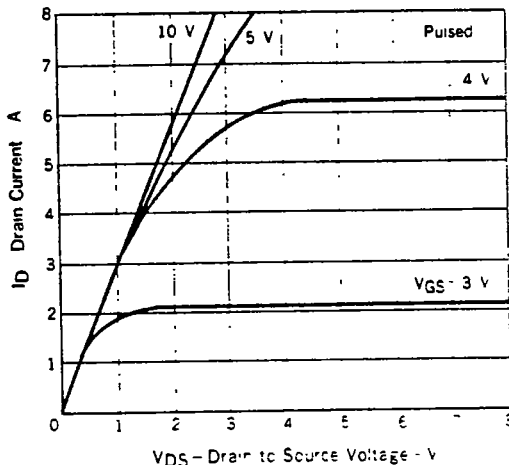

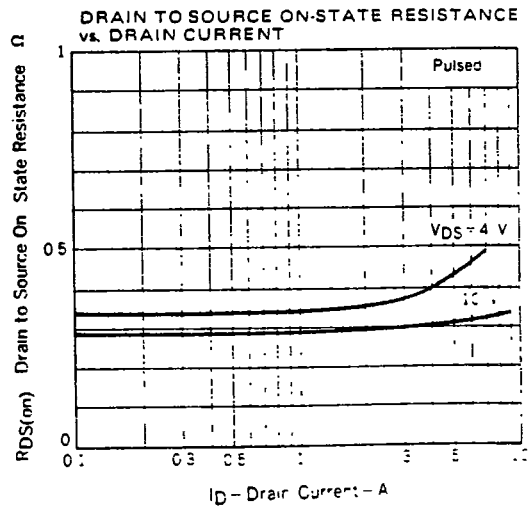
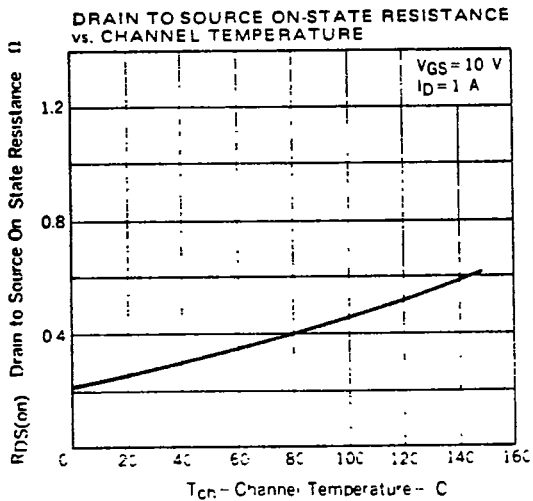
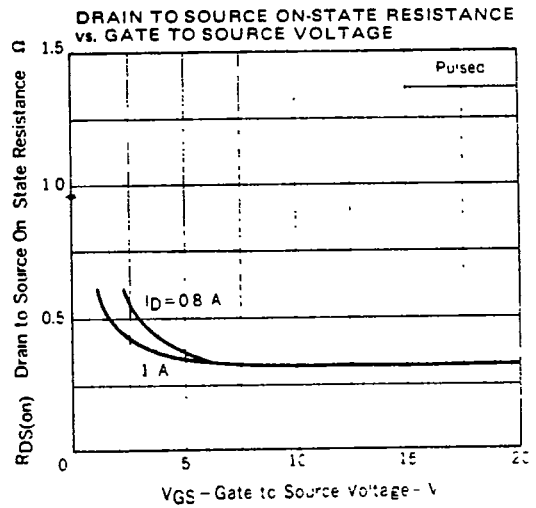
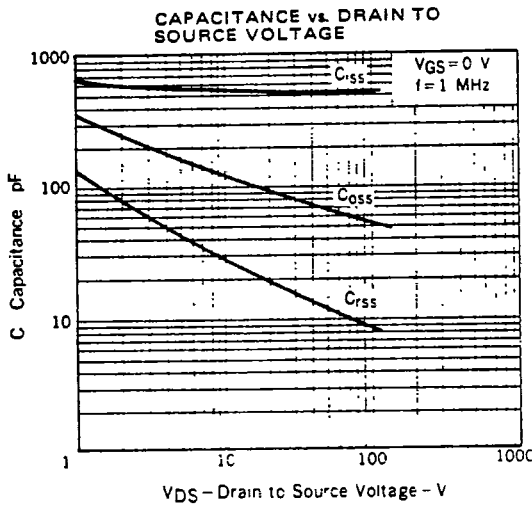
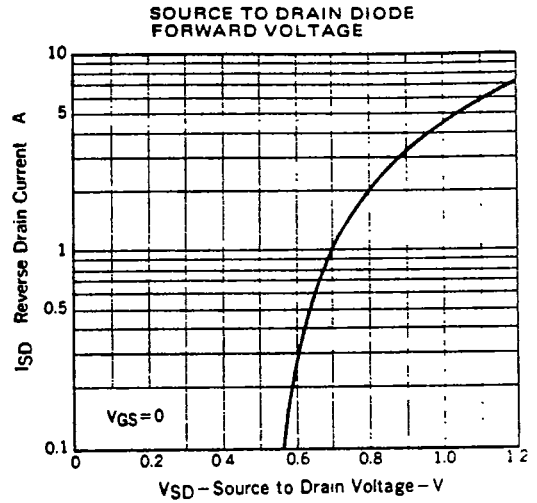
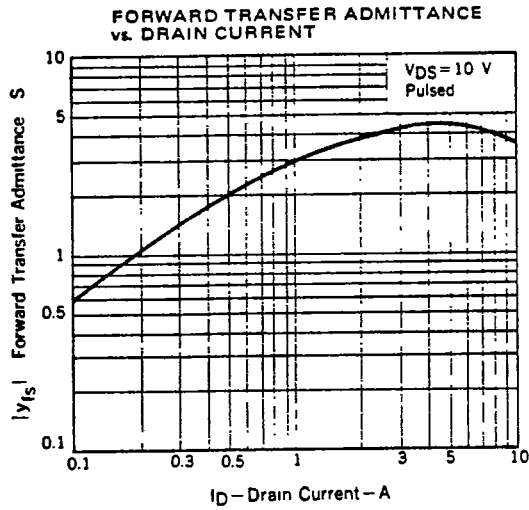

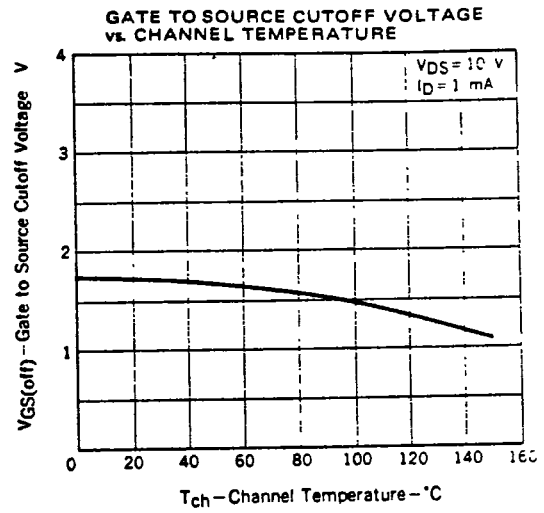
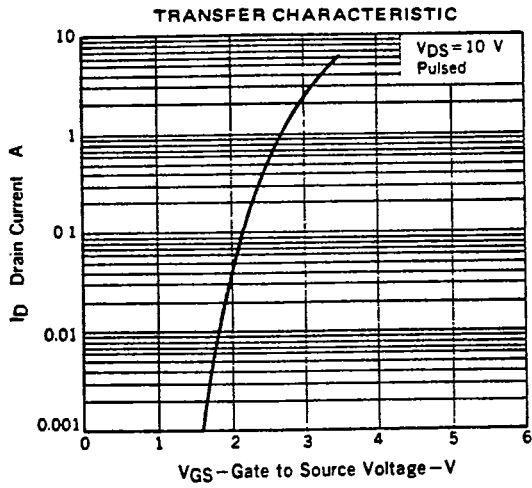

4

This datasheet has been downloaded from:

www.DatasheetCatalog.com

Datasheets for electronic components.